

# Minimalism and functionality

## Yori





**Reggiani**  
NORTH AMERICA



# Yori

- **Yori Surface/Pendant**
- **Yori Linear**
- **Yori Wall**
- **Yori Track**
- **Yori Recessed**
- **Yori Monopoint**
- **Yori 48V**

Minimalism and rigour in the service of functionality, Yori is a high performance luminaire with a compact footprint.





**Finishes:**

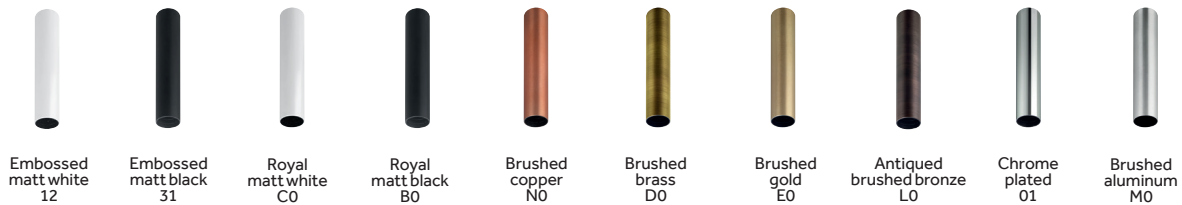

Embossed matt white 12    Embossed matt black 31    Royal matt white C0    Royal matt black B0    Brushed copper N0    Brushed brass D0    Brushed gold E0    Antiqued brushed bronze L0    Chrome plated 01    Brushed aluminum M0

**Versions:**

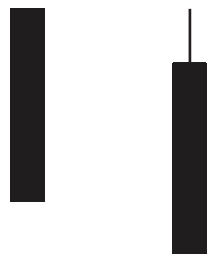

Surface    Pendant

**Optics:**



Narrow    Medium    Wide    Very Wide

1" dia x 6"L / 16"L / 31.5"L / 63"L	9°	24°	32°	
1.4" dia x 6"L / 16"L / 31.5"L	8°	22°	28°	
2.4" dia x 8"L / 10"L / 24"L	12°	20°	32°	
3.7" dia x 10"L / 13"L / 16"L / 31.5"L	12°	24°	38°	53°

**Yori Pendant Mounting Options:**



4' Cord

**Accessories:**

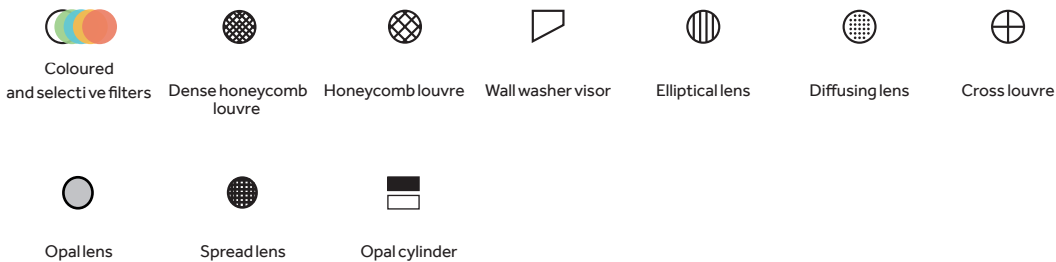

Coloured and selective filters    Dense honeycomb louvre    Honeycomb louvre    Wall washer visor    Elliptical lens    Diffusing lens    Cross louvre  
Opal lens    Spread lens    Opal cylinder

## Surface Technical Features:

Ø 1"

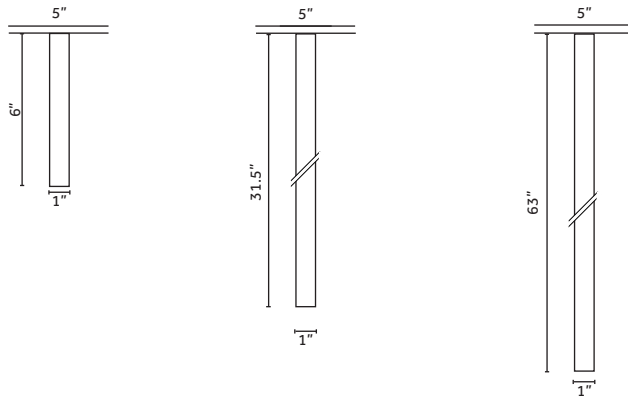

2 W  
Lumen delivered up to 110lm  
L90 B10=50,000 h  
2700K, 3000K, 3500K, 4000K  
CRI >80, CRI >90  
Dimming 0-10V, Phase-cut  
Remote driver

Ø 1.4"

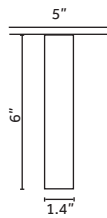

3.5 W  
Lumen delivered up to 192lm  
L90 B10=50,000 h  
2700K, 3000K, 3500K, 4000K  
CRI >80, CRI >90  
Dimming 0-10V, Phase-cut  
Remote driver

Ø 2.4"

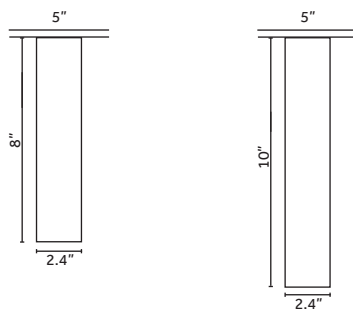

5W / 8" long, 9W / 10" long  
Lumen delivered up to 650lm; 1000lm  
L80 B10=50,000 h  
2700K, 3000K, 3500K, 4000K  
CRI >80, CRI >90  
Dimming 0-10V, Phase-cut  
Remote driver

Warm Dimming  
6W / 10" Long  
Lumen delivered up to 350Lm  
Lumen maintenance: L70 B50=50,000h.  
1700K-3000K  
CRI >95  
Dimming 0-10V  
Remote driver

Ø 3.7"

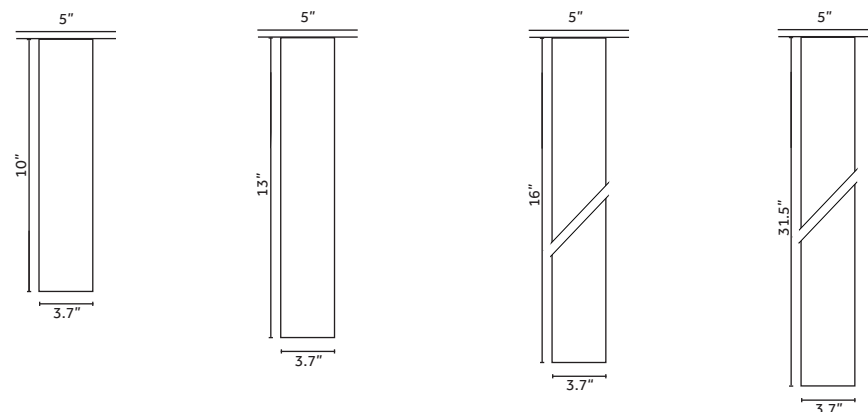

12W / 10" long, 17W / 13" long,  
24W / 16" and 31.5" long  
Lumen delivered up to 1500lm; 2100lm; 2800lm  
L80 B10=50,000 h  
2700K, 3000K, 3500K, 4000K  
CRI >80, CRI >90  
Dimming 0-10V, Phase-cut,  
Lutron EcoSystem  
Remote driver

Warm Dimming  
25W / 16" and 31.5" long  
Lumen delivered up to 1200lm  
1700K-3000K  
CRI >95  
Dimming 0-10V, Phase-cut,  
Lutron Ecosystem  
Remote driver

- Custom length up to 94.5" on request.

- Watt lumen data refer to nominal values of the LED source, for photometric data visit [www.reggianiusa.com](http://www.reggianiusa.com).

- For 3500K, must consult with factory to confirm availability.



**Pendant Technical Features:**

**Ø 1"**

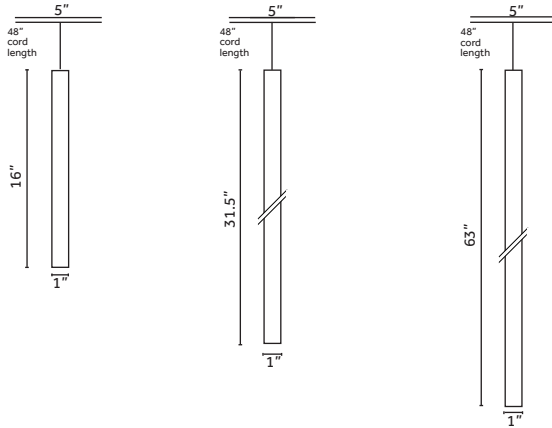

2 W  
Lumen delivered up to 110lm  
L90 B10=50,000 h  
2700K, 3000K, 3500K, 4000K  
CRI >80, CRI >90  
Dimming 0-10V, Phase-cut  
Remote driver

**Ø 1.4"**

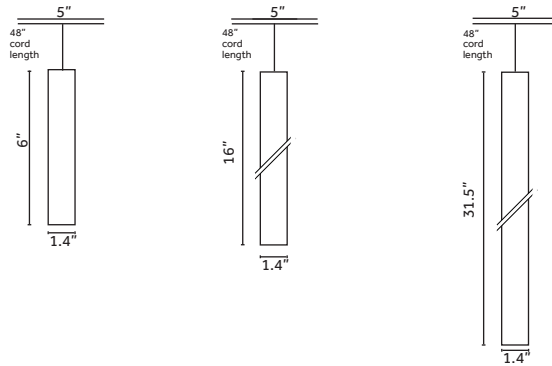

3.5 W  
Lumen delivered up to 192lm  
L90 B10=50,000 h  
2700K, 3000K, 3500K, 4000K  
CRI >80, CRI >90  
Dimming 0-10V, Phase-cut  
Remote driver

**Ø 2.4"**

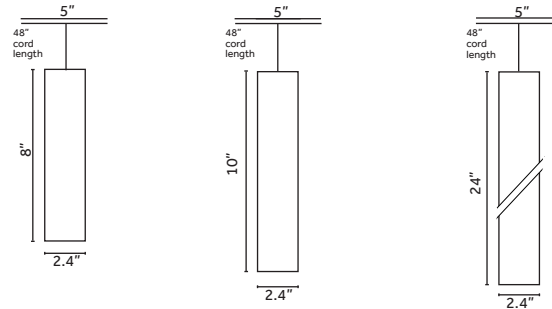

5W / 8" long; 9W / 10" long; 12W / 24" long  
Lumen delivered up to 650lm; 1000lm; 1400lm  
L80 B10=50,000 h  
2700K, 3000K, 3500K, 4000K  
CRI >80, CRI >90  
Dimming 0-10V, Phase-cut  
Remote driver

Warm Dimming  
6W / 10" long; 12W / 24" long  
Lumen delivered up to 350Lm; 690Lm  
Lumen maintenance: L70 B50=50,000h.  
1700K-3000K  
CRI >95  
Dimming 0-10V, Phase-cut  
Remote driver

**Ø 3.7"**

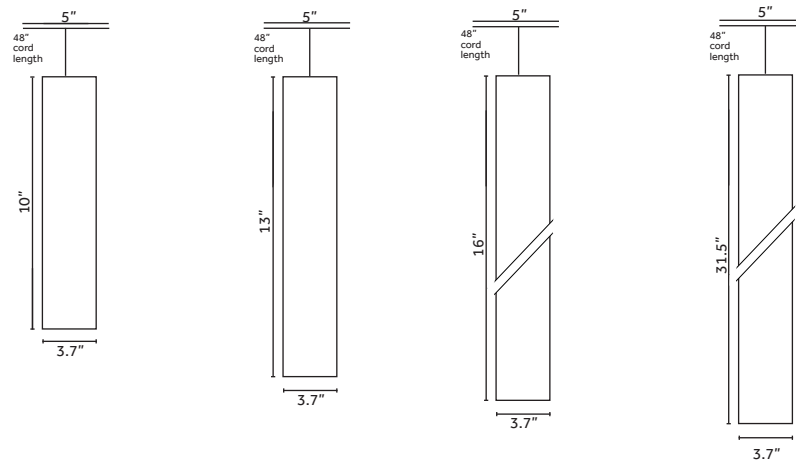

12W / 10" long; 17W / 13" long;  
24W / 16" and 31.5" long  
Lumen delivered up to 1500lm;  
2100lm; 2800 lm  
L80 B10=50,000 h  
2700K, 3000K, 3500K, 4000K  
CRI >80, CRI >90  
Dimming 0-10V, Phase-cut,  
Lutron EcoSystem  
Remote driver

Warm Dimming  
25W / 16" and 31.5" long  
Lumen delivered up to 1200lm  
1700K-3000K  
CRI >95  
Dimming 0-10V, Phase-cut,  
Lutron Ecosystem  
Remote driver

**Opal Cylinder Sizes:**



**Closed  
version**



**Hollow  
version**

**Ø1"**

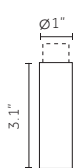
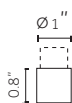

**Ø1.4"**

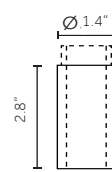
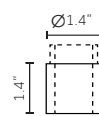
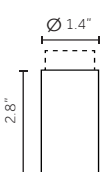
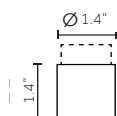

**Ø2.4"**

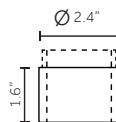

**Ø3.7"**

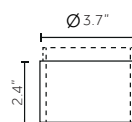

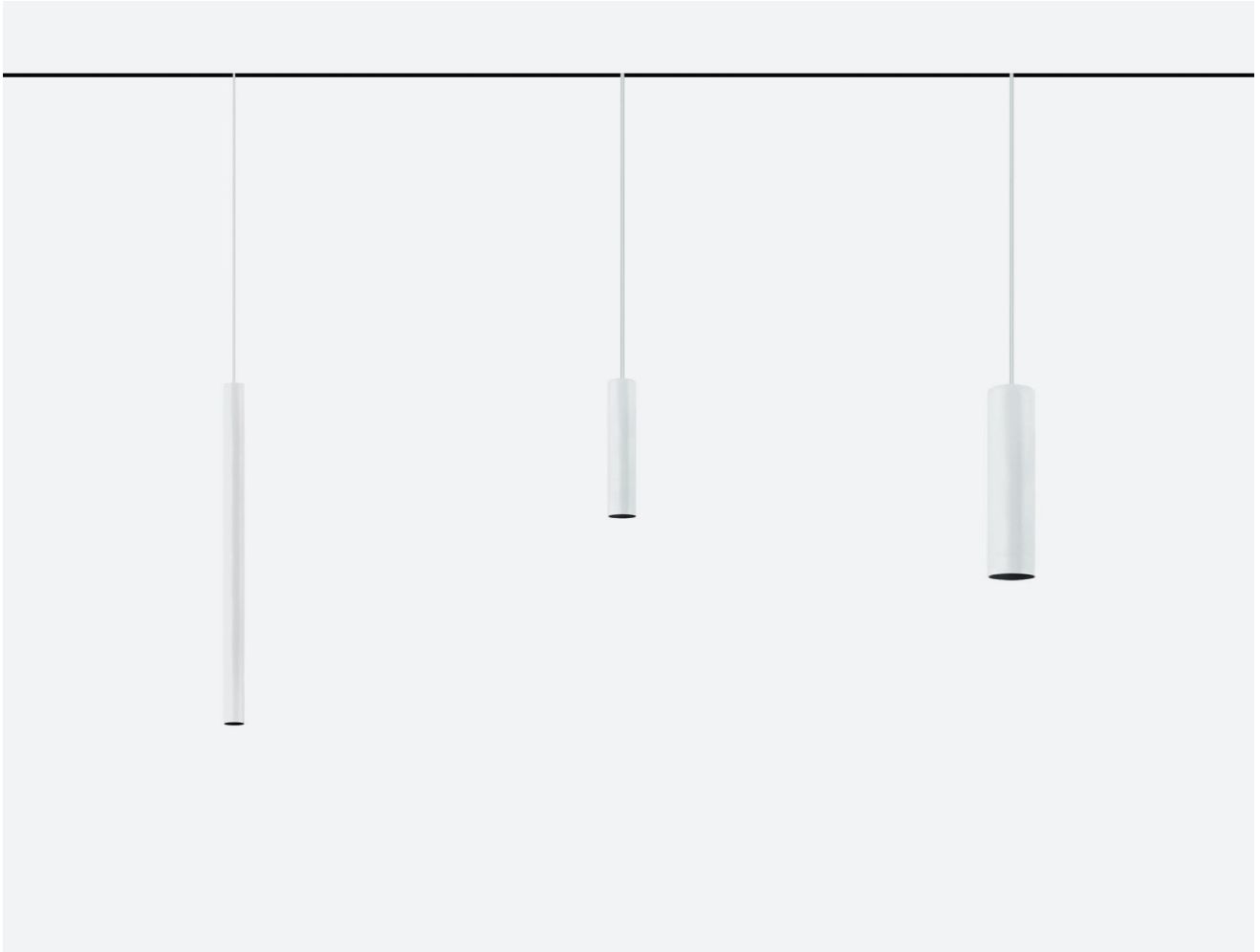

# Yori Linear Track

Yori Linear provides comfortable diffuse illumination that complements accent lighting. This linear solution is suitable for track mounting applications to integrate with the profile of the Yori Track Head. With five different diffusers and a variety of lengths for a single, connected or continuous line of light, the possibilities are endless.

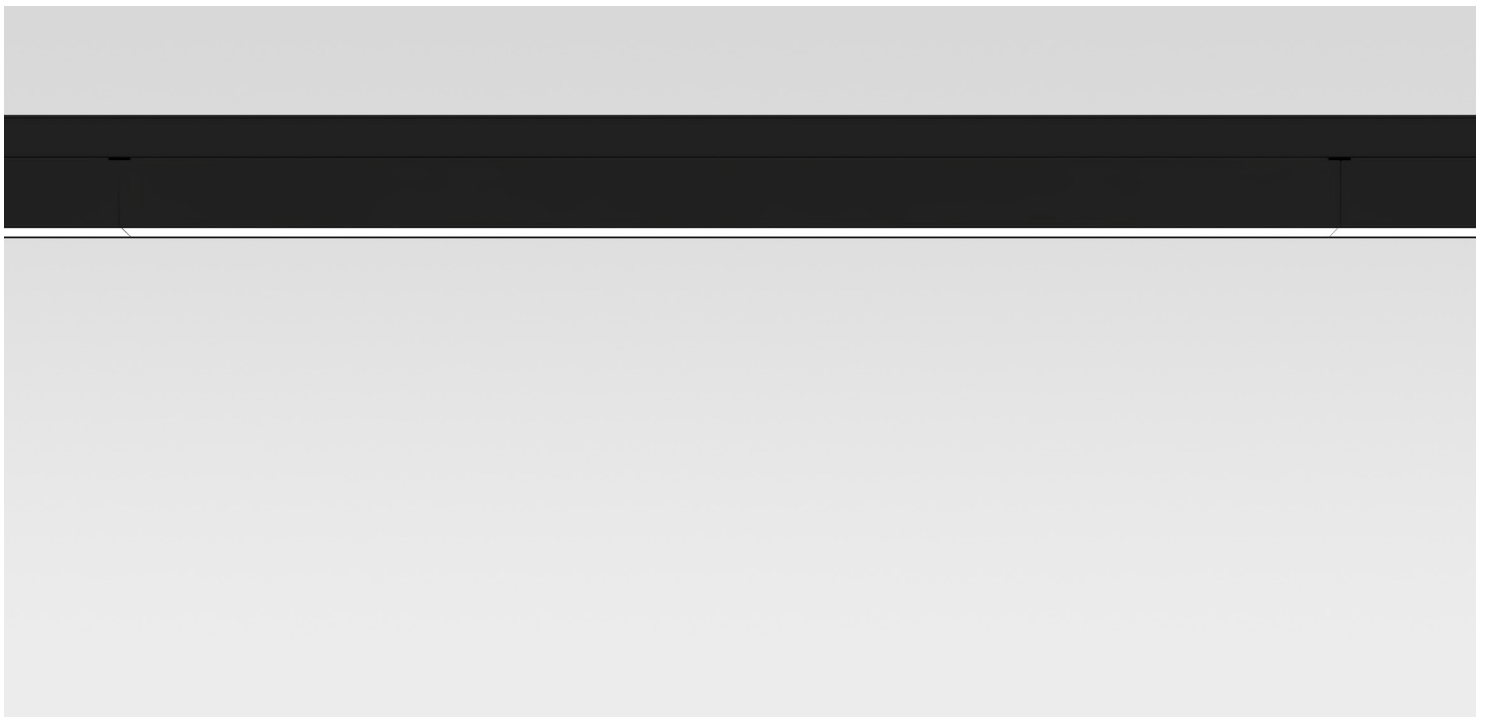

**Finishes:**



Embossed  
matt white  
12

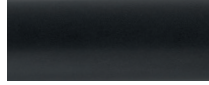

Embossed  
matt black  
12

**Product Sizes:**



1.5 ft



3 ft



4.5 ft

**System Options:**



Single



Continuous line

**Optical Options:**



Opal



Prismatic



Louver  
(UGR 19)



Opal  
U-Shape



Ribbed

**Technical Features:**

**1.5ft**

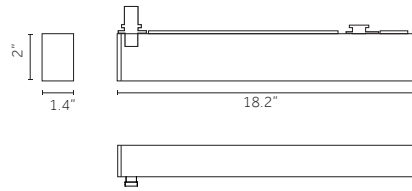

13W  
Lumen delivered up to 1870lm  
L70 B10=50.000 h  
2700K, 3000K, 3500K, 4000K  
CRI >80, CRI >90  
Dimming Phase-cut

**3ft**

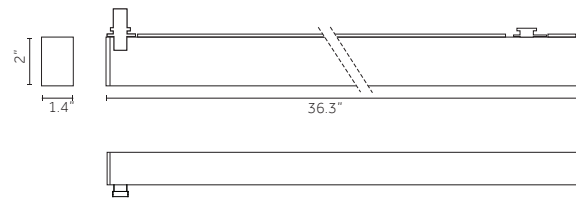

26W  
Lumen delivered up to 3570lm  
L70 B10=50.000 h  
2700K, 3000K, 3500K, 4000K  
CRI >80, CRI >90  
Dimming Phase-cut

**4.5ft**

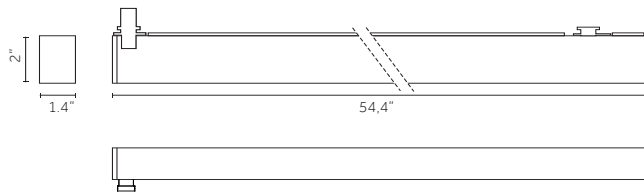

38W  
Lumen delivered up to 4850lm  
L70 B10=50.000 h  
2700K, 3000K, 3500K, 4000K  
CRI >80, CRI >90  
Dimming Phase-cut

**Continuous Line:**

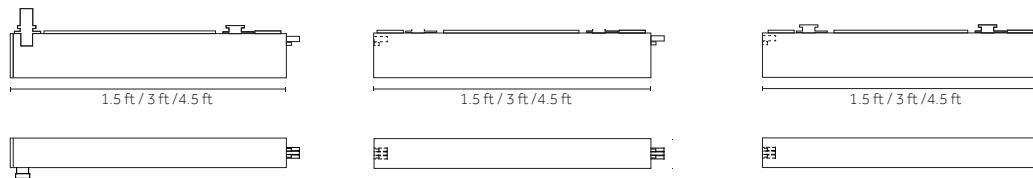

- Watt lumen data refer to nominal values of the LED source, for photometric data visit [www.reggianiusa.com](http://www.reggianiusa.com).  
- For 3500K, must consult with factory to confirm availability.



# Yori Linear Recessed

Yori Linear is available in single modules or in a continuous line configuration. The elegant, practical continuous line is provided by combining luminaires of different lengths fitted with special plug and socket connectors. Yori Linear Recessed features an elegant, understated line with a very minimal trim. The continuous line configuration of Yori Linear recessed includes a 90° corner module for even more versatile lighting design projects.

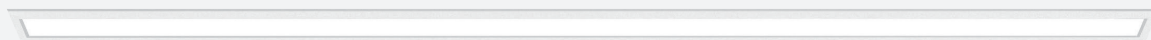



**Finishes:**



Embossed  
matt white  
12



Embossed  
matt black  
12

**Product Sizes:**



1.5 ft



3 ft



4.5 ft

**System Options:**



Single



Continuous line



90 module

**Optical Options:**



Opal



Prismatic



Louver  
(UGR 19)



Ribbed

**Technical Features:**

**1.5ft**

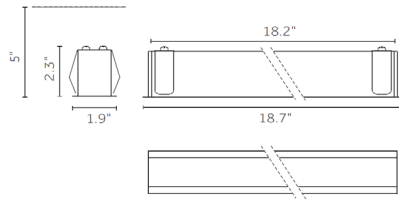

13W  
 Lumen delivered up to 1870lm  
 L70 B10 =50,000h  
 2700K, 3000K, 3500K, 4000K  
 CRI >80, CRI >90  
 Dimming 0-10V, Phase-cut,  
 Lutron EcoSystem  
 Remote driver

**3ft**

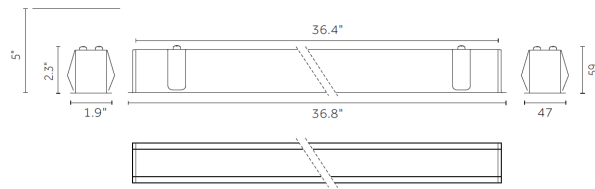

26W  
 Lumen delivered up to 3570lm  
 L70 B10 =50,000h  
 2700K, 3000K, 3500K, 4000K  
 CRI >80, CRI >90  
 Dimming 0-10V, Phase-cut,  
 Lutron EcoSystem  
 Remote driver

**4.5ft**

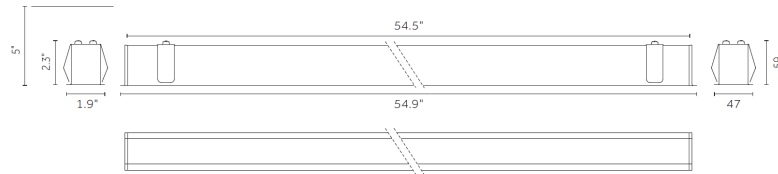

38W  
 Lumen delivered up to 4850lm.  
 L70 B10 =50,000h  
 2700K, 3000K, 3500K, 4000K  
 CRI >80, CRI >90  
 Dimming 0-10V, Phase-cut,  
 Lutron EcoSystem  
 Remote driver

**Technical Features:**

**Continuous Line:**

**1.5ft**

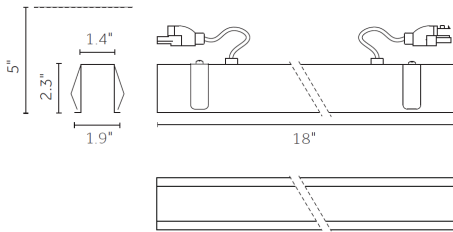

13W  
Lumen delivered up to 1870lm  
L70 B10 =50,000h  
2700K, 3000K, 3500K, 4000K  
CRI >80, CRI >90  
Dimming 0-10V, Phase-cut,  
Lutron EcoSystem  
Remote driver

**3ft**

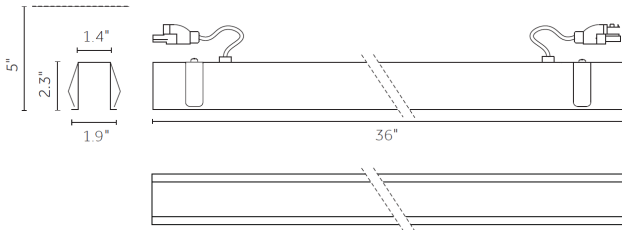

26W  
Lumen delivered up to 3570lm  
L70 B10 =50,000h  
2700K, 3000K, 3500K, 4000K  
CRI >80, CRI >90  
Dimming 0-10V, Phase-cut,  
Lutron EcoSystem  
Remote driver

**4.5ft**

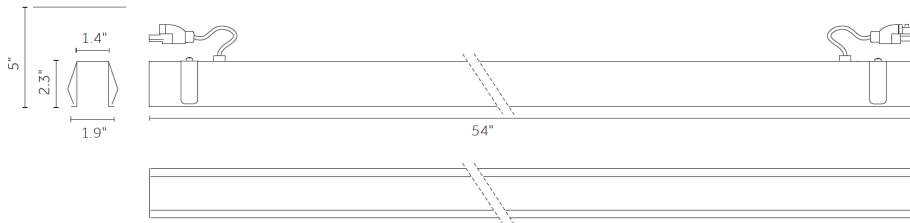

38W  
Lumen delivered up to 4850lm.  
L70 B10 =50,000h  
2700K, 3000K, 3500K, 4000K  
CRI >80, CRI >90  
Dimming 0-10V, Phase-cut,  
Lutron EcoSystem  
Remote driver

**3ft 90° Module**

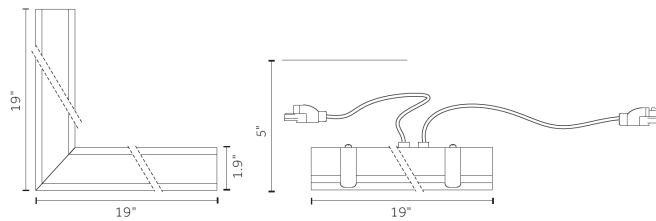

26W  
Lumen delivered up to 3570lm  
L70 B10 =50,000h  
2700K, 3000K, 3500K, 4000K  
CRI >80, CRI >90  
Dimming 0-10V, Phase-cut,  
Lutron EcoSystem  
Remote driver

**Also available in 2,4,6 and 8ft for acoustic tile ceiling (ATC)**

- Watt lumen data refer to nominal values of the LED source, for photometric data visit [www.reggianiusa.com](http://www.reggianiusa.com).  
- For 3500K, must consult with factory to confirm availability.

# Yori Wall

Transform any interior with this comprehensive range of wall mounted architectural luminaires. Yori Wall offers a huge degree of flexibility: beyond the three basic sizes there are different high-end finishes, interchangeable optics and direct-indirect light versions.



**Finishes:**

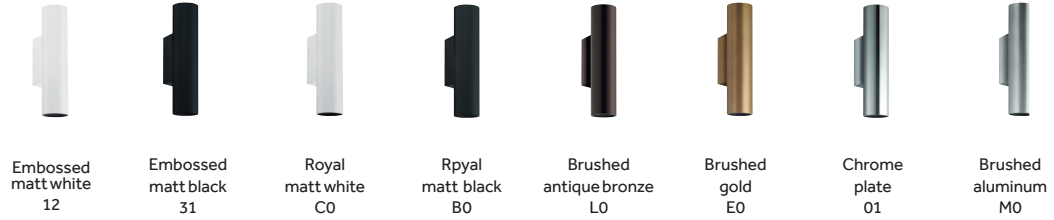

**Versions:**

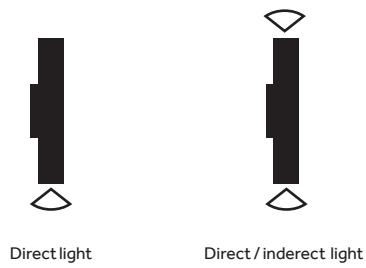

**Optics:**



1.4" dia x 8.3"L  
2.4" dia x 9.8"L  
3.7" dia x 15.6"L

8°	22°		
12°	20°	32°	
12°	24°	38°	53°

**Accessories:**

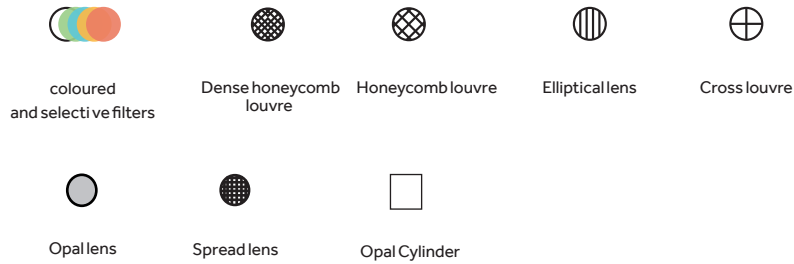

## Technical Features:

### Ø1.4"

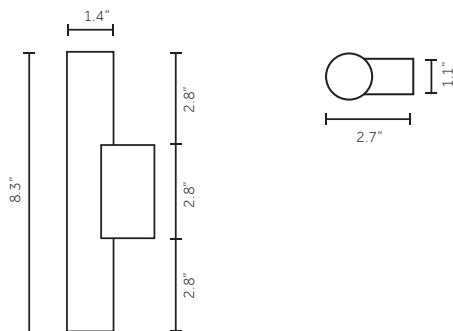

Single emission:  
3.5W  
Lumen delivered up to 310lm  
L90 B10=50,000 h  
2700K, 3000K, 3500K, 4000K  
CRI >80, CRI >90  
Dimming 0-10V  
Remote driver

Double emission:  
2W x 2  
Lumen delivered up to  
160+ 160lm  
L90 B10=50,000 h  
2700K, 3000K, 3500K, 4000K  
CRI >80, CRI >90  
Dimming 0-10V  
Remote driver

### Ø2.4"

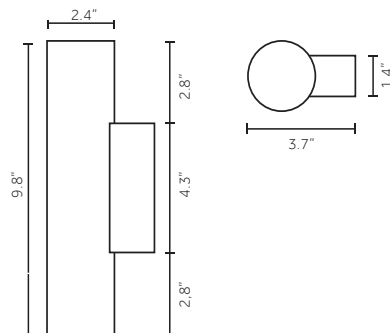

Single emission:  
9W  
Lumen delivered up to 1115lm  
L80 B50=50,000 h  
2700K, 3000K, 3500K, 4000K  
CRI >80, CRI >90  
Dimming 0-10V,  
Lutron EcoSystem  
Remote driver

Double emission:  
5W x 2  
Lumen delivered up to  
720+720lm  
L80 B50=50,000 h  
2700K, 3000K, 3500K, 4000K  
CRI >80, CRI >90  
Dimming 0-10V,  
Lutron EcoSystem  
Remote driver

### Ø3.7"

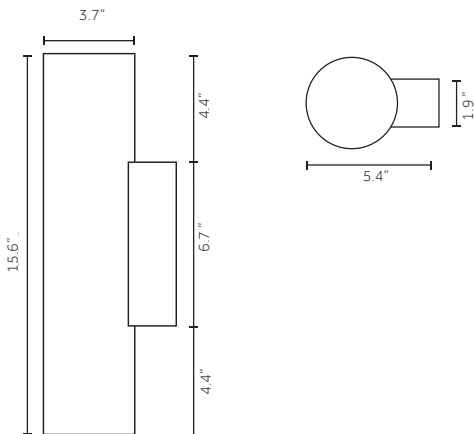

Single emission:  
25W  
Lumen delivered up to 2800lm  
L80 B50=50,000 h  
2700K, 3000K, 3500K, 4000K  
CRI >80, CRI >90  
Dimming 0-10V, Phase-cut,  
Lutron EcoSystem  
Remote driver

Double emission:  
12W x 2  
Lumen delivered up to  
1540+1540lm  
L80 B50=50,000 h  
2700K, 3000K, 3500K, 4000K  
CRI >80, CRI >90  
Dimming 0-10V, Phase-cut,  
Lutron EcoSystem  
Remote driver

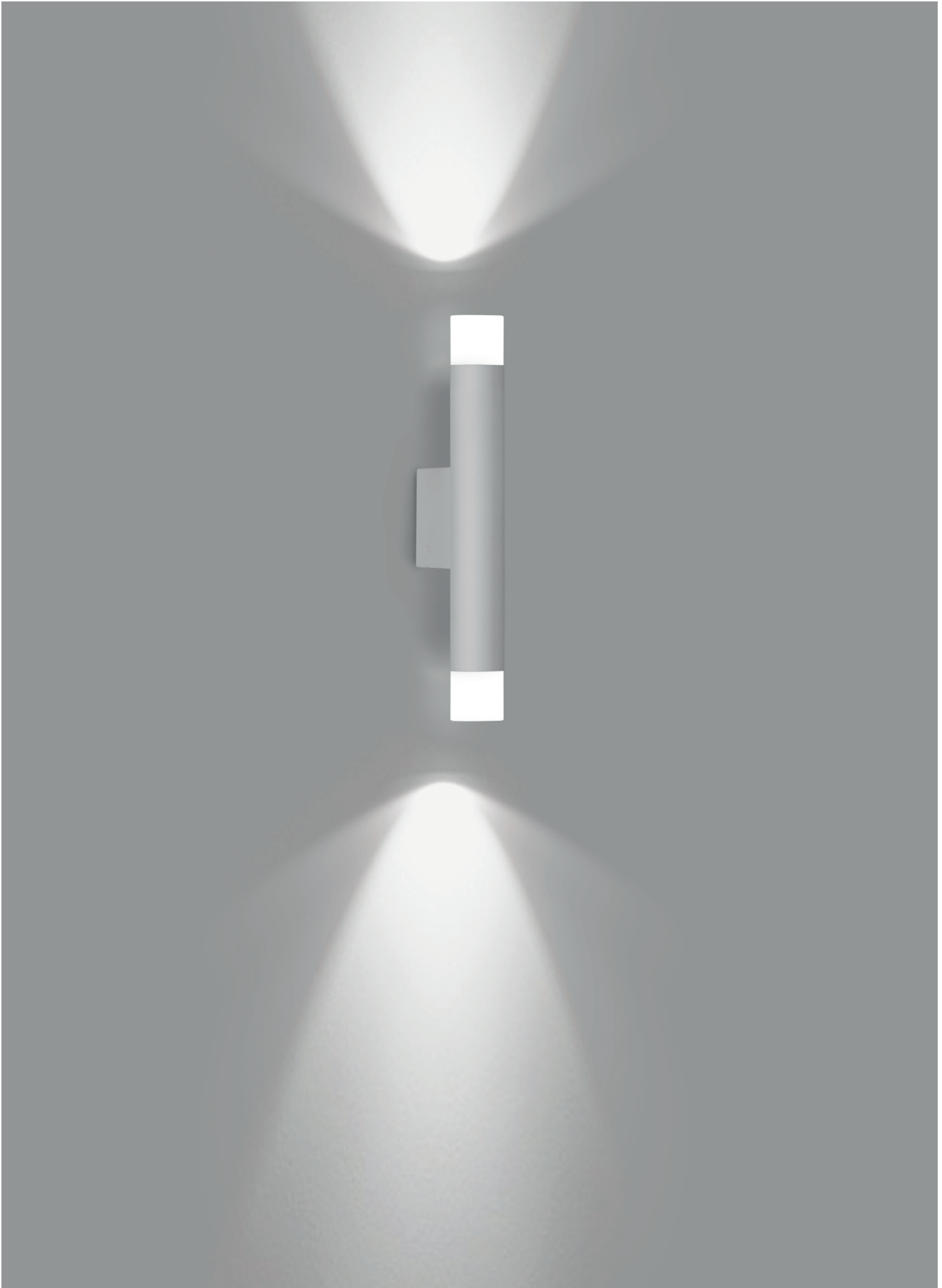

# Yori Evo Box

The Yori Evo Box extends the features of the Yori range to a flexible track mounted accent light with a simple, elegant design. It comes in four sizes and features the Precision and Performance optics with different light output, beam angles and intensity. The accessories that complete this family make it even more versatile.





**Finishes:**



Embossed  
matt white  
12



Embossed  
matt black  
31

Special finishes on request

**Product Sizes:**



Ø 1.7"



Ø 2.4"



Ø 3.0"



Ø 3.7"

**Optics:**



Narrow



Medium



Wide



Very Wide

1.7" dia Precision	8°	11°	23°	40°
1.7" dia Performance	8°	18°	29°	
2.4" dia Precision	8°	20°	32°	
2.4" dia Performance	13°	24°	39°	
3.0" dia Precision	7°	23°		
3.0" dia Performance	12°	23°	37°	48°
3.7" dia Precision	7°	24°		
3.7" dia Performance	10°	20°	31°	40°

**Accessories:**



coloured  
and selective filters



Dense honeycomb  
louvre



Honeycomb louvre



Wall washer visor



Elliptical lens



Cross louvre



Opal lens



Spread lens

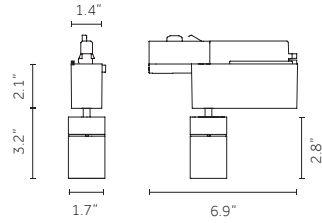

Barn doors

**Technical Features:****Ø1.7**

4W,9W  
Lumen delivered up to 435/750lm Precision  
Lumen delivered up to 450/780lm Performance  
L90 B10=50,000 h  
2700K, 3000K, 3500K, 4000K  
CRI >80, CRI >90  
Dimming 0-10V, Phase-cut,  
Lutron EcoSystem

Warm Dimming COB LED  
6.5W  
Lumen delivered up to 130lm  
L80 B10=50,000 h  
1700K- 3000K  
CRI >95  
Phase-cut

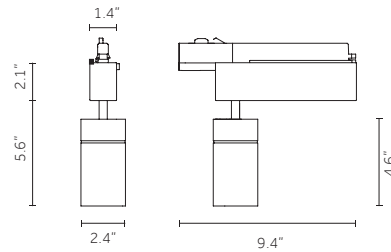
**Ø2.4"**

9W,12W,17W  
Lumen delivered up to 1115/1455/1970lm  
Precision  
Lumen delivered up to 1200/1560/2110lm  
Performance  
L80 B10=50,000 h  
2700K, 3000K, 3500K, 4000K  
CRI >80, CRI >90, CRI >98  
Dimming 0-10V, Phase-cut,  
Lutron EcoSystem

Warm Dimming COB LED  
12W  
Lumen delivered up to 690lm  
L70 B10=50,000 h  
1700K-3000K  
CRI >95  
Dimming 0-10V, Phase-cut,  
Lutron EcoSystem

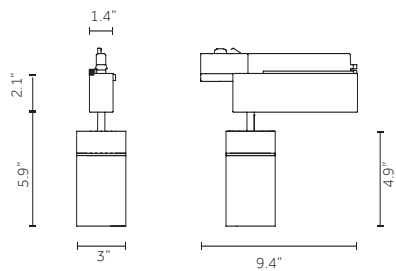
**Ø3"**

12W,17W, 24W,28W  
Lumen delivered up to 1575/2190/2955/3325lm  
Precision  
Lumen delivered up to 1800/2399/3550/3770lm  
Performance  
L80 B10=50,000 h  
2700K, 3000K, 3500K, 4000K  
CRI >80, CRI >90, CRI >98  
Dimming 0-10V, Phase-cut,  
Lutron EcoSystem

Warm Dimming COB LED  
25W  
Lumen delivered up to 1100lm  
L70 B10=50,000 h  
1700K-3000K,  
CRI >95  
Dimming 0-10V, Phase-cut

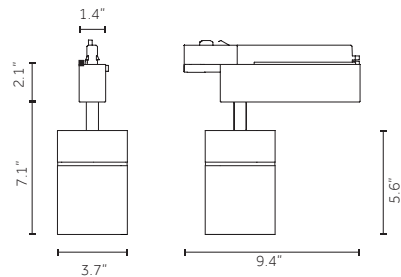
**Ø3.7"**

12W,17W, 24W,33W,37W  
Lumen delivered up to  
1690/2351/3170/4130/4477lm Precision  
Lumen delivered up to  
1800/2500/3500/4110/4530lm Performance  
L90 B10=50,000 h  
2700K, 3000K, 3500K, 4000K  
CRI >80, CRI >90, CRI >98  
Dimming 0-10V, Phase-cut,  
Lutron EcoSystem

Warm Dimming COB LED  
33W  
Lumen delivered up to 1520lm  
L70 B10=50,000 h  
1700K-3000K  
CRI >95  
Dimming 0-10V, Phase-cut



# Yori Recessed

Yori Recessed is a high performance luminaire with a compact footprint. Available in two sizes, four shapes, and trim or trimless. The light engine can be completely hidden inside the ceiling plane and function as a downlight, or it may be pulled below the ceiling plane and adjusted.



**Finishes:**



**Product Sizes:**

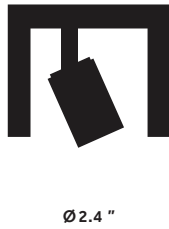

**Shapes:**

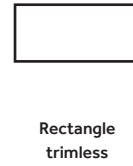
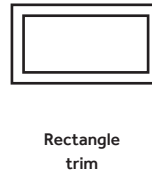
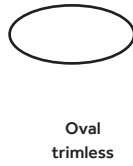
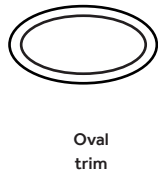
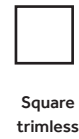
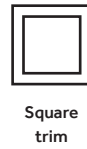

**Optics:**



**Accessories:**



**Technical Features:**

**Ø2.4" Round**

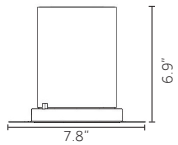
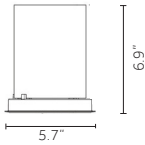
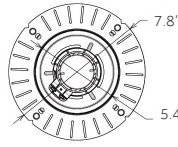
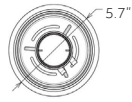

9W,12W  
 Lumen delivered up to 1115/1455lm Precision  
 Lumen delivered up to 1200/1560lm Performance  
 L80 B10=50,000h  
 2700K, 3000K, 3500K, 4000K  
 CRI >80, CRI >90, CRI >98  
 Dimming 0-10V, Phase-cut,  
 Lutron EcoSystem

Warm Dimming COB LED  
 12W  
 Lumen delivered up to 690lm Precision  
 L90 B10=50,000h  
 1700K- 3000K  
 CRI >95  
 Dimming 0-10V, Phase-cut,  
 Lutron EcoSystem

**Ø2.4" Square**

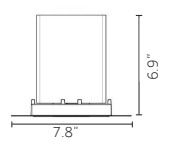
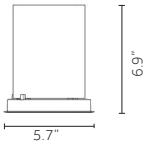
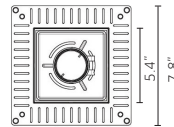
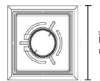

9W,12W  
 Lumen delivered up to 1115/1455lm Precision  
 Lumen delivered up to 1200/1560lm Performance  
 L80 B10=50,000h  
 2700K, 3000K, 3500K, 4000K  
 CRI >80, CRI >90, CRI >98  
 Dimming 0-10V, Phase-cut,  
 Lutron EcoSystem

Warm Dimming COB LED  
 12W  
 Lumen delivered up to 690lm Precision  
 L90 B10=50,000h  
 1700K-3000K,  
 CRI >95  
 Dimming 0-10V, Phase-cut,  
 Lutron EcoSystem

**Ø2.4" Rectangle**

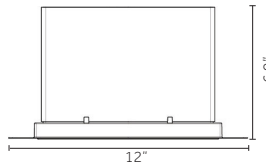
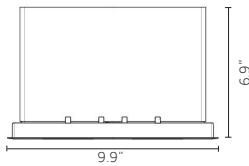
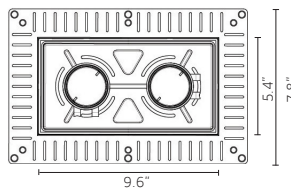
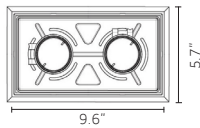

9Wx2,12Wx2  
 Lumen delivered up to 1115x2/1455x2lm Precision  
 Lumen delivered up to 1200x2/1560x2lm Performance  
 L80 B10=50,000h  
 2700K, 3000K, 3500K, 4000K  
 CRI >80, CRI >90, CRI >98  
 Dimming 0-10V, Phase-cut,  
 Lutron EcoSystem

Warm Dimming COB LED  
 12Wx2  
 Lumen delivered up to 690x2lm Precision  
 L90 B10=50,000h  
 1700K- 3000K  
 CRI >95  
 Dimming 0-10V, Phase-cut,  
 Lutron EcoSystem

**Ø2.4" Oval**

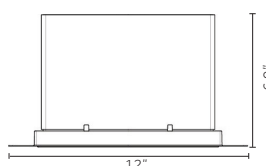
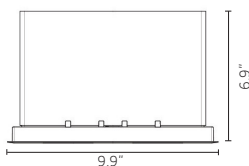
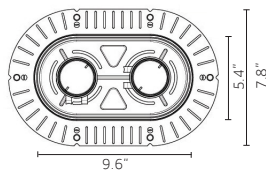
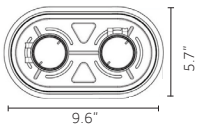

9Wx2,12Wx2  
 Lumen delivered up to 1115x2/1455x2lm Precision  
 Lumen delivered up to 1200x2/1560x2lm Performance  
 L80 B10=50,000h  
 2700K, 3000K, 3500K, 4000K  
 CRI >80, CRI >90, CRI >98  
 Dimming 0-10V, Phase-cut,  
 Lutron EcoSystem

Warm Dimming COB LED  
 12Wx2  
 Lumen delivered up to 690x2lm Precision  
 L90 B10=50,000h  
 1700K -3000K,  
 CRI >95  
 Dimming 0-10V, Phase-cut,  
 Lutron EcoSystem

Ø3.7" Round

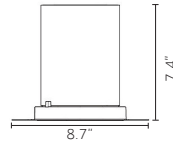
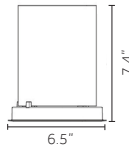
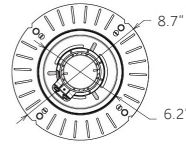
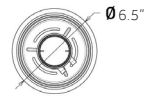

12W,17W,24W  
Lumen delivered up to 1690/2350/3170lm  
Precision  
Lumen delivered up to 1800/2500/3300lm  
Performance  
L70 B10=50,000h  
2700K, 3000K, 3500K,4000K  
CRI >80, CRI >90, CRI >98  
Dimming 0-10V, Phase-cut,  
Lutron EcoSystem

Ø3.7" Square

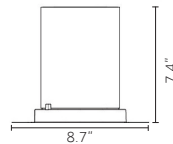
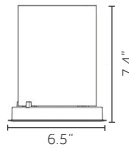
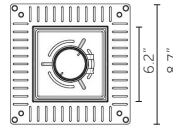
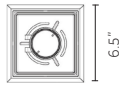

12W,17W,24W  
Lumen delivered up to 1690/2350/3170lm  
Precision  
Lumen delivered up to 1800/2500/3300lm  
Performance  
L70 B10=50,000h  
2700K, 3000K, 3500K,4000K  
CRI >80, CRI >90, CRI >98  
Dimming 0-10V, Phase-cut

Ø3.7" Rectangle

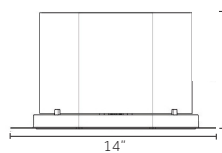
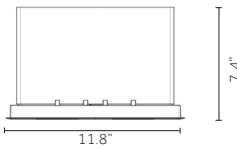
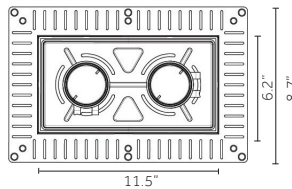
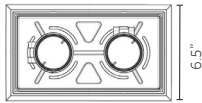

12Wx2,17Wx2  
Lumen delivered up to 1690x2/2350x2lm  
Precision  
Lumen delivered up to 1800x2/2500x2lm  
Performance  
L70 B10=50,000h  
2700K, 3000K, 3500K,4000K  
CRI >80, CRI >90, CRI >98  
Dimming 0-10V, Phase-cut

Ø3.7" Oval

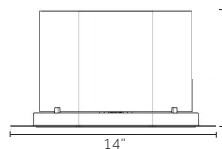
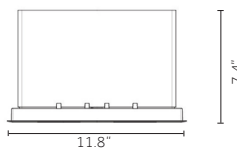
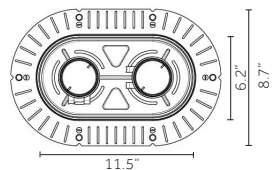

12Wx2,17Wx2  
Lumen delivered up to 1690x2/2350x2lm  
Precision  
Lumen delivered up to 1800x2/2500x2lm  
Performance  
L70 B10=50,000h  
2700K, 3000K, 3500K,4000K  
CRI >80, CRI >90, CRI >98  
Dimming 0-10V, Phase-cut

- Watt lumen data refer to nominal values of the LED source, for photometric data visit [www.reggianiusa.com](http://www.reggianiusa.com).  
- For 3500K, must consult with factory to confirm availability







# Yori Monopoint

The Yori Monopoint extends the features of the Yori range to a surface mounted adjustable accent light with a simple, elegant design. It comes in four sizes and features the Precision and Performance optics with different light output, beam angles and intensity. The accessories that complete this family make it even more versatile.



**Finishes:**



Embossed  
matt white  
12



Embossed  
matt black  
31

**Product Sizes:**



Ø 1.7 "



Ø 2.4 "



Ø 3.0 "

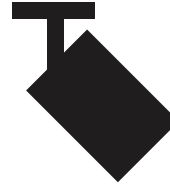

Ø 3.7 "

**Optics:**



Narrow



Medium



Wide



Very Wide

**Accessories:**



Coloured  
and selective filters



Dense honeycomb  
louvre



Honeycomb louvre



Wall washer visor



Elliptical lens



Cross louvre



Opal lens



Spread lens



Barn doors

## Technical Features:

### Ø1.7

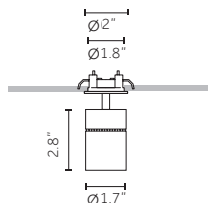

4W,9W  
Lumen delivered up to 435/750lm Precision  
Lumen delivered up to 450/780lm Performance  
L90 B10=50,000h  
2700K, 3000K, 3500K,4000K  
CRI >80, CRI >90  
Dimming 0-10V, Phase-cut, Lutron EcoSystem  
Remote driver

Warm Dimming COB LED  
6,5W  
Lumen delivered up to 130lm  
L80 B10=50,000h  
1700K-3000K  
CRI >95  
Dimming 0-10V, Phase-cut  
Remote driver

### Ø2.4"

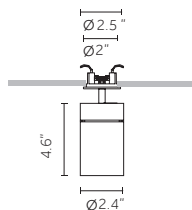

9W,12W,17W  
Lumen delivered up to 1115/1455/1970lm Precision  
Lumen delivered up to 1200/1560/2110lm Performance  
L80 B10 = 50,000h  
2700K, 3000K, 3500K,4000K  
CRI >80, CRI >90, CRI >98  
Dimming 0-10V, Phase-cut, Lutron EcoSystem  
Remote driver

Warm Dimming COB LED  
12W  
Lumen delivered up to 690lm  
L70 B50=50,000h  
1700K-3000K  
CRI >95  
Dimming 0-10V, Phase-cut, Lutron EcoSystem  
Remote driver

### Ø3"

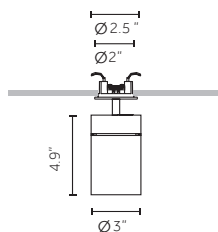

12W,17W,24W  
Lumen delivered up to 1575/2190/2955lm Precision  
Lumen delivered up to 1800/2399/3350lm Performance  
L80 B10=50,000h  
2700K, 3000K, 3500K,4000K  
CRI >80, CRI >90, CRI >98  
Dimming 0-10V, Phase-cut, Lutron EcoSystem  
Remote driver

Warm Dimming COB LED  
25W  
Lumen delivered up to 1100lm  
L70 B50=50,000h  
1700K-3000K  
CRI >95  
Dimming 0-10V, Phase-cut  
Remote driver

### Ø3.7"

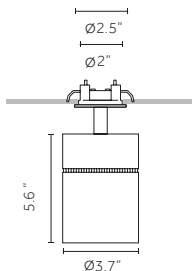

12W,17W,24W  
Lumen delivered up to 1690/2350/3170lm Precision  
Lumen delivered up to 1800/2500/3300lm Performance  
L80 B10=50,000h  
2700K, 3000K, 3500K,4000K  
CRI >80, CRI >90  
Dimming 0-10V, Phase-cut, Lutron EcoSystem  
Remote driver

- Watt lumen data refer to nominal values of the LED source, for photometric data visit [www.reggianiusa.com](http://www.reggianiusa.com).

- For 3500K, must consult with factory to confirm availability

- Junction box option available for all sizes



# Yori Channel & Channel Arm

Yori Channel & Channel Arm are high performance luminaires with compact footprints.

Yori Channel can be pendant, recessed, or surface mounted, while Yori Channel Arm has an articulating arm and is surface mounted in a cove.



**Finishes:**



Embossed  
matt white  
12



Embossed  
matt black  
31

**Product  
Sizes:**



Ø 2.4 "



Ø 3.7 "



Ø 2.4 "



Ø 3.7 "

**Optics:**



Narrow



Medium



Wide



Very Wide

**Accessories:**



Coloured  
and selective filters



Dense honeycomb  
louvre



Honeycomb louvre



Wall washer visor



Elliptical lens



Cross louvre



Opal lens



Spread lens

**Technical Features:**

**Ø2.4**

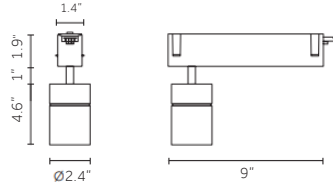

9W,12W,17W  
 Lumens delivered up to 1115/1455/1970lm Precision  
 Lumens delivered up to 1200/1560/2110lm Performance  
 L80 B10=50,000h  
 2700K, 3000K, 3500K, 4000K  
 CRI >80, CRI >90, CRI >98  
 Dimming 0-10V, Phase-cut  
 Warm Dimming COB LED  
 12W  
 Lumens delivered up to 690lm  
 L70 B50=50,000h  
 1700K-3000K  
 CRI >95  
 Dimming 0-10V, Phase-cut

**Ø3.7"**

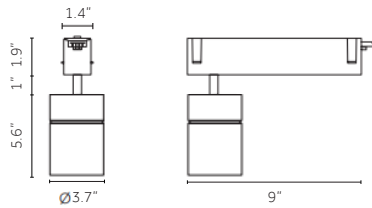

12W,17W,24W,33W, 37W  
 Lumen delivered up to 1690/2351/3170/4130/4477lm Precision  
 Lumen delivered up to 1800/2500/3300/4110/4530lm Performance  
 L90 B10=50,000hCRI  
 2700K, 3000K, 3500K, 4000K  
 CRI >80, CRI >90, CRI >98  
 Dimming 0-10V, Phase-cut  
 Warm Dimming COB LED  
 33W  
 Lumens delivered up to 1520lm  
 L70 B10=50,000h  
 1700K-3000K  
 CRI >95  
 Dimming 0-10V, Phase-cut

**Ø2.4"**

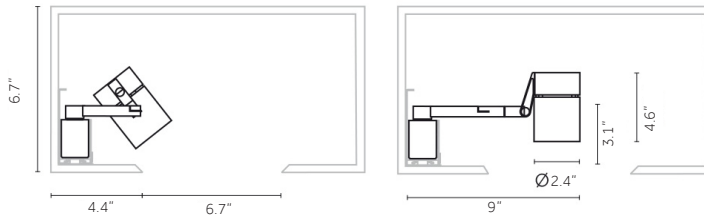

9W,12W,17W  
 Lumens delivered up to 1115/1455/1970lm Precision  
 Lumens delivered up to 1200/1560/2110lm Performance  
 L80 B10=50,000h  
 2700K, 3000K, 3500K, 4000K  
 CRI >80, CRI >90, CRI >98  
 Dimming 0-10V, Phase-cut

**Ø3.7"**

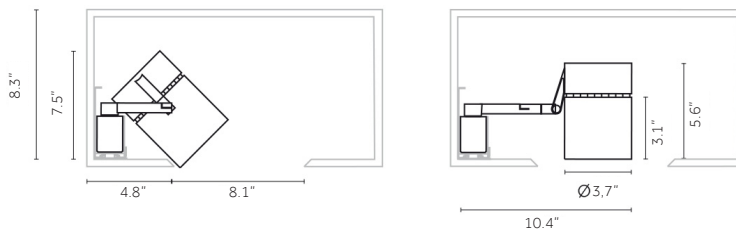

12W,17W,24W,33W, 37W  
 Lumen delivered up to 1690/2351/3170/4130/4477lm Precision  
 Lumen delivered up to 1800/2500/3300/4110/4530lm Performance  
 L90 B10=50,000h  
 2700K, 3000K, 3500K, 4000K  
 CRI >80, CRI >90, CRI >98  
 Dimming 0-10V, Phase-cut



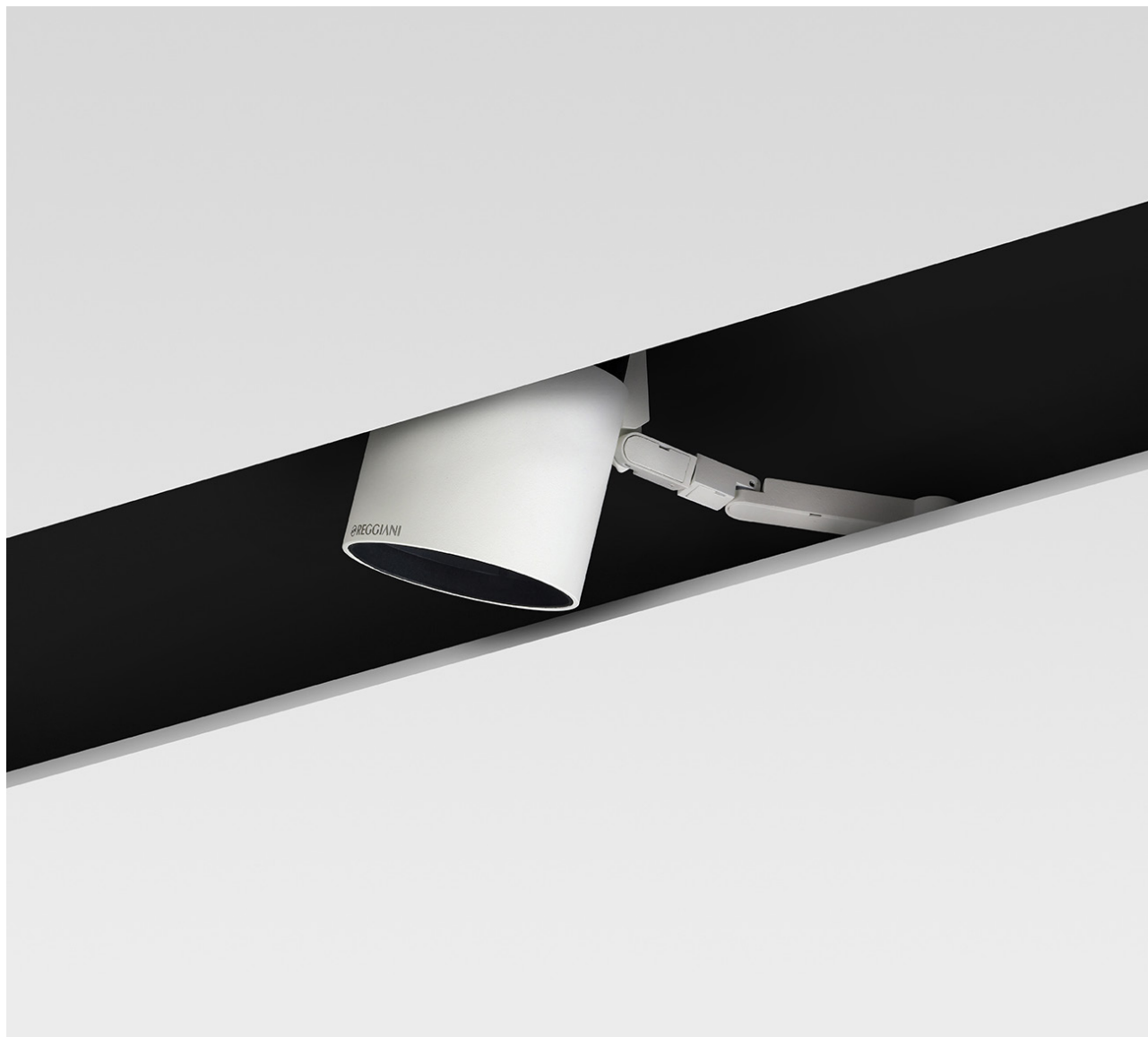

# Yori Evo 48V

The Yori Evo family has evolved and widened, now including a 48V low-voltage track system available with adjustable spotlights, pendants, and linears in a range of different sizes. In presenting a product or a piece of art, light plays an essential role; Yori Evo 48V adds new dimensions, performance and unique flexibility to the offering. The outstanding CRI>98 option enhances colors, authenticity, and materiality, adding value to any sales item or art object and drawing viewers' attention to it.

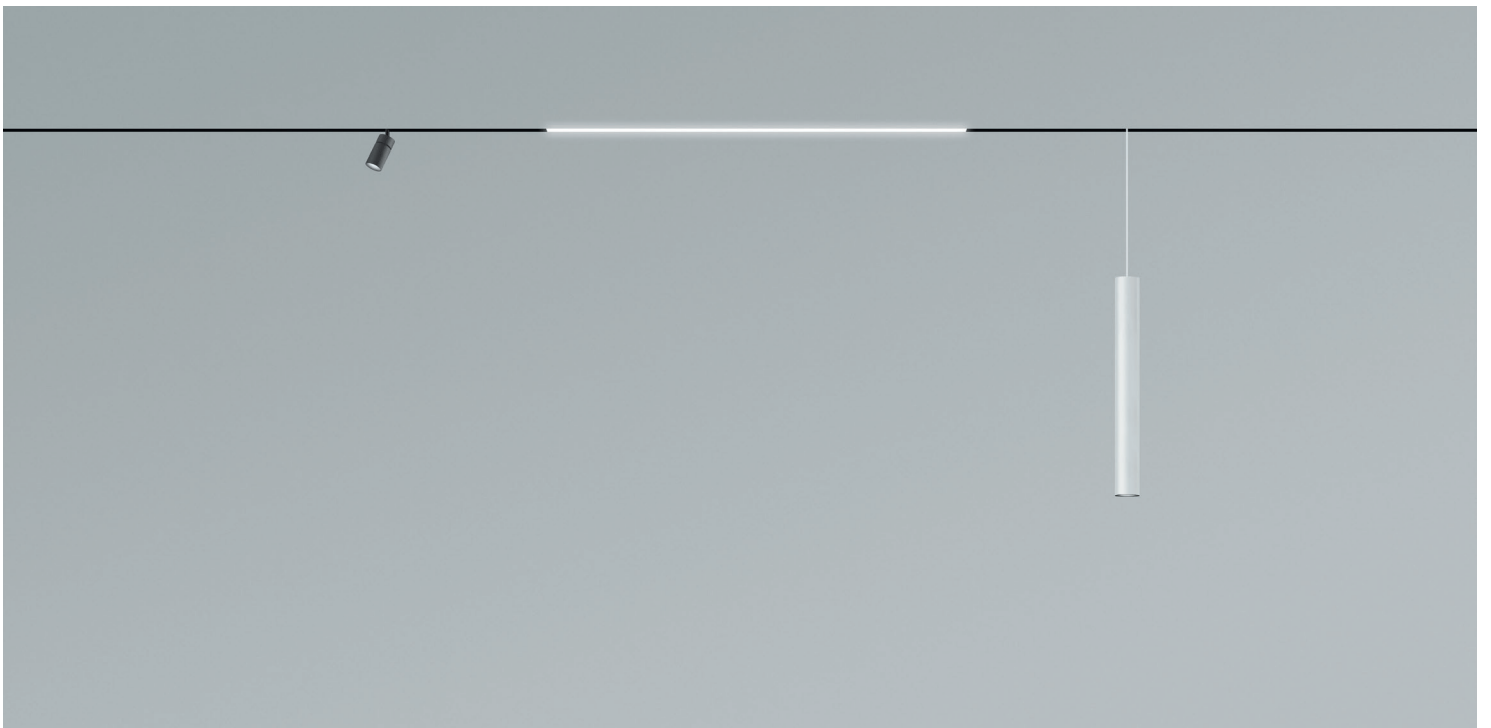

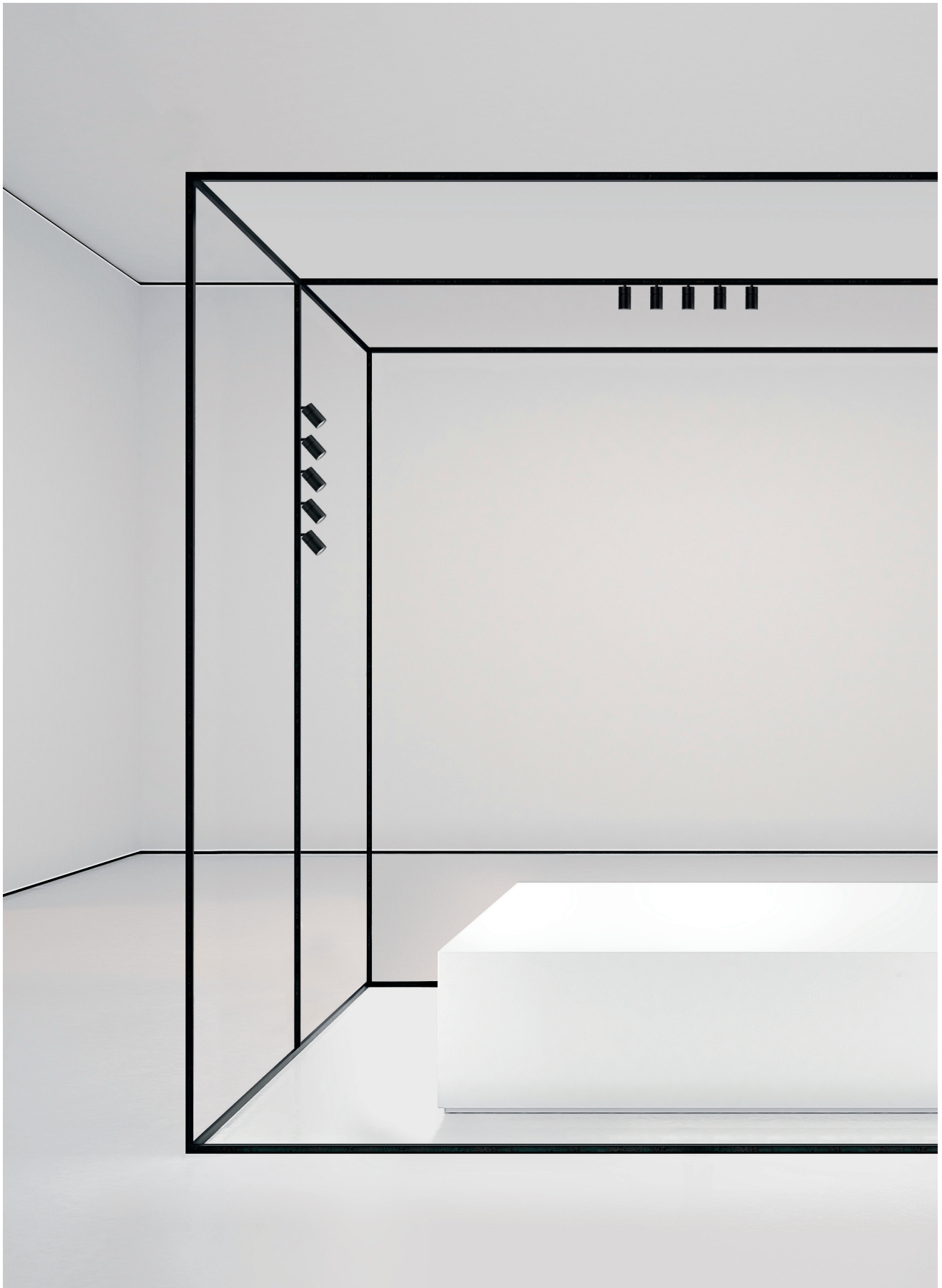

**Yori Pendant 48V**

**Finishes:**

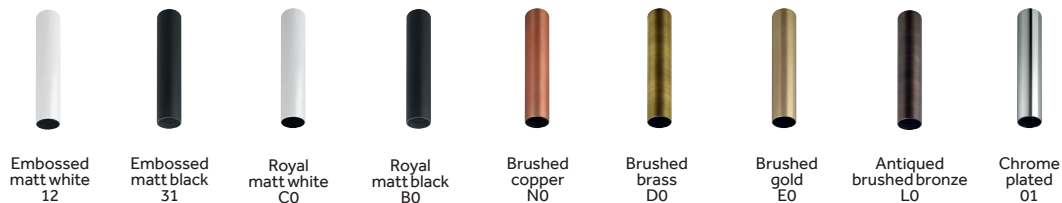

**Optics:**



1" dia x 16"L / 31.5"L / 63"L  
 1.4" dia x 6"L / 16"L / 31.5"L  
 2.4" dia x 10"L

	10°	28°	33°
	10°	22°	31°
8°	12°	20°	32°

**Yori Pendant Mounting:**



48" Cord

**Accessories:**

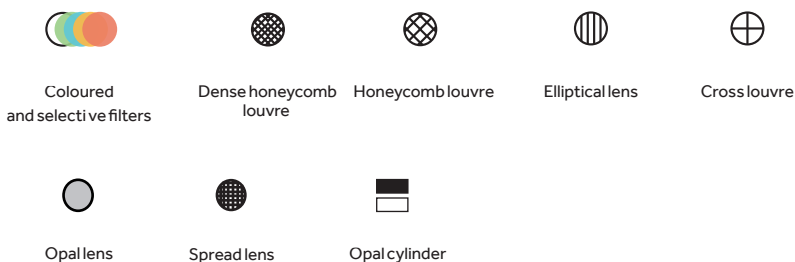

**Technical Features:**

**Ø 1"**

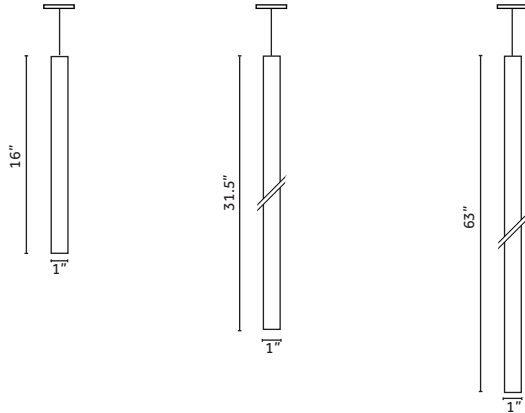

2W  
 Lumen delivered up to 110lm  
 L90 B10=50,000h  
 2700K, 3000K, 3500K, 4000K  
 CRI >80, CRI >90  
 Dimming 0-10V, DALI, On/Off

**Ø1.4"**

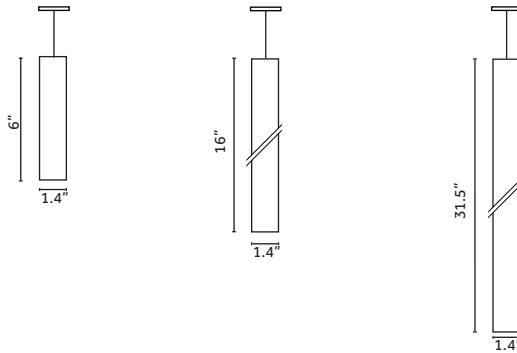

2.4W, 3.5W  
 Lumen delivered up to 192lm  
 L90 B10=50,000h  
 2700K, 3000K, 3500K, 4000K  
 CRI >80, CRI >90  
 Dimming 0-10V, DALI, On/Off

**Ø2.4"**



9W  
 Lumen delivered up to 1000lm  
 L90 B10=50,000h  
 2700K, 3000K, 3500K, 4000K  
 CRI >80, CRI >90  
 Dimming 0-10V, DALI, On/Off

### Yori Evo 48V

#### Finishes:

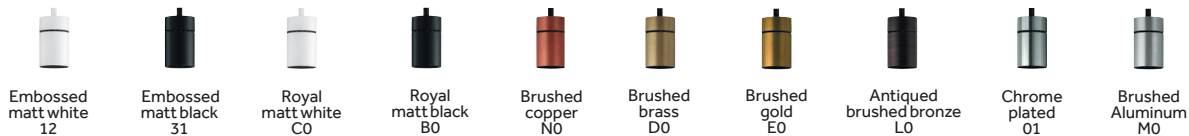

#### Product Sizes:

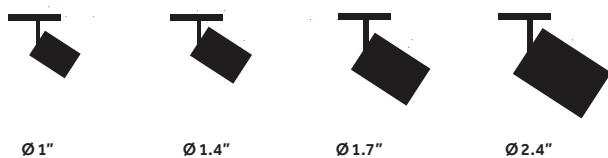

#### Optics:



#### Accessories:

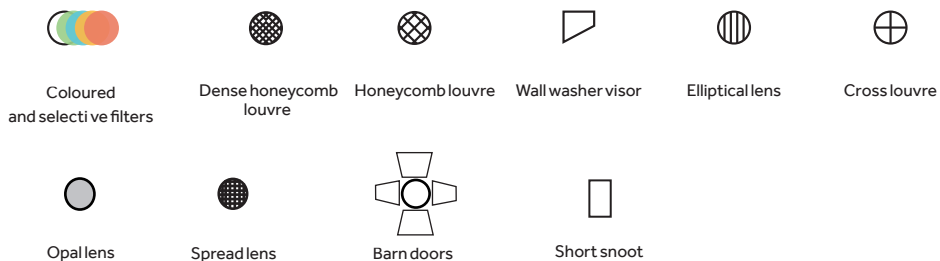

Technical Features:

Ø1"

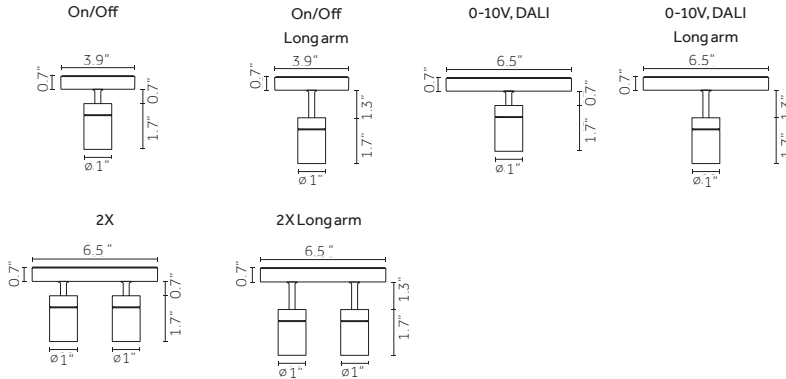

2W, 2Wx2  
Lumen delivered up to 110lm / 210lm x 2  
L90 B10=50,000h  
2700K, 3000K, 3500K, 4000K  
CRI >80, CRI >90  
Dimming 0-10V, DALI, On/Off

Ø1.4"

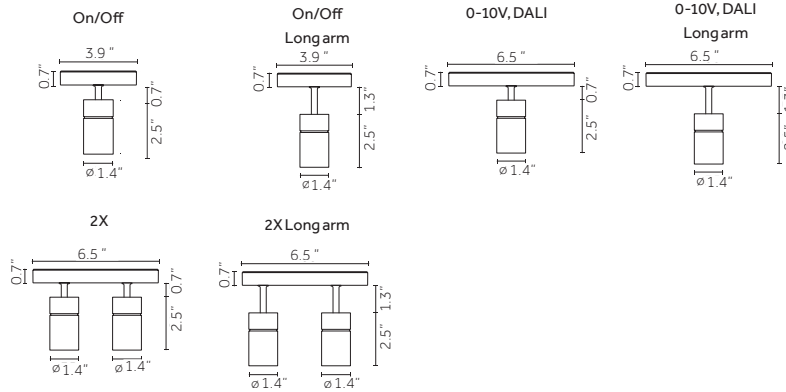

2.4W, 2.4Wx2  
Lumen delivered up to 270lm / 270 x 2lm  
L90 B10=50,000h  
2700K, 3000K, 3500K, 4000K  
CRI >80, CRI >90  
Dimming 0-10V, DALI, On/Off

Ø1.7"

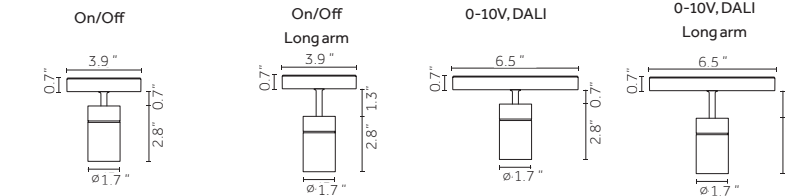

4W, 9W  
Lumen delivered up to 435lm / 750lm Precision  
Lumen delivered up to 450lm / 780lm Performance  
L90 B10=50,000h  
2700K, 3000K, 3500K, 4000K  
CRI >80, CRI >90  
Dimming 0-10V, DALI, On/Off

Ø2.4"

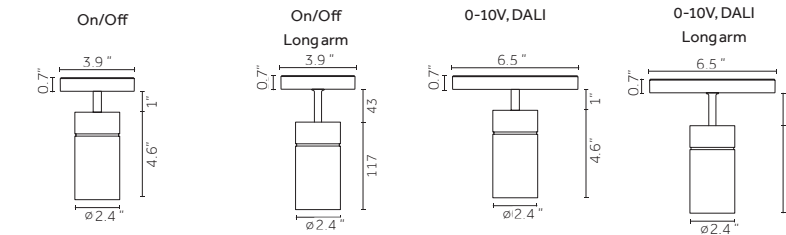

9W, 12W, 17W  
Lumen delivered up to 1115lm / 1455lm / 1970lm Precision  
Lumen delivered up to 1560lm / 2110lm Performance  
L90 B10=50,000h  
2700K, 3000K, 3500K, 4000K  
CRI >80, CRI >90, CRI >98  
Dimming 0-10V, DALI, On/Off

### Yori Linear 48V

#### Finishes:



Embossed  
matt white  
12

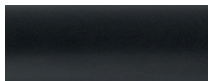

Embossed  
matt black  
12

#### Product Sizes:



11.3"



22.3"



33.3"



44.4"



55.4"

#### Optical Options:



Opal



Prismatic



UGR 19 High Performance





Yori Linear 48V  
Opal diffuser

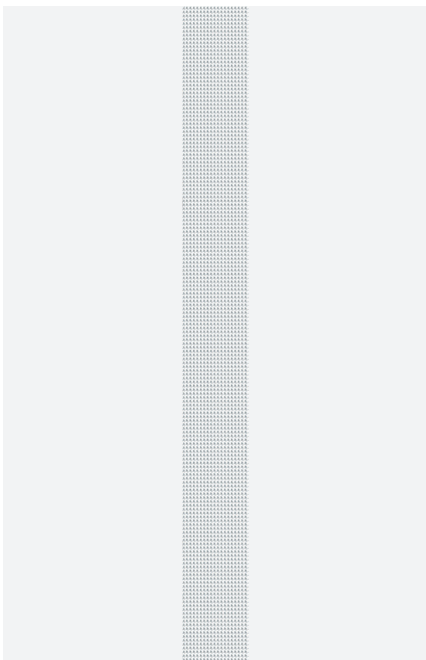

Yori Linear 48V  
Prismatic diffuser

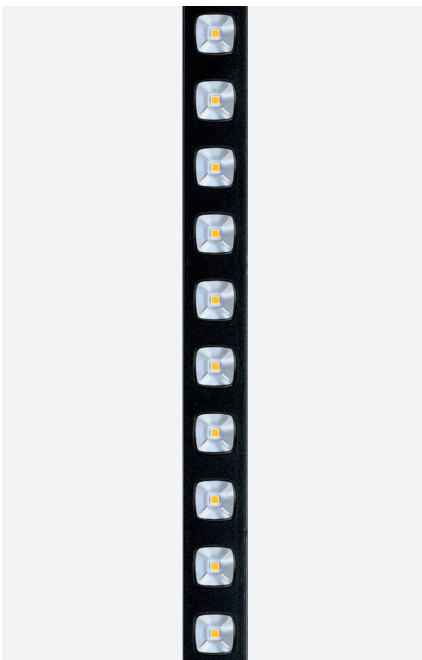

Yori Linear 48V  
UGR <19

Yori Linear 48V - Opal diffuser	Yori Linear 48V - Prismatic diffuser	Yori Linear 48V - UGR<19
---------------------------------	--------------------------------------	--------------------------



High-Performance

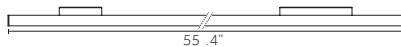
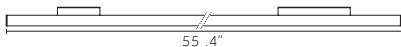
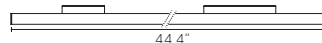
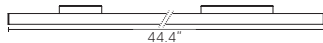
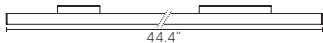

Lengths: 5.4W/11.3", 10.8W/22.3", 16.2W/33.3", 21.6W/44.4", 27W/55.4"  
Lumen delivered up to 525lm,1078lm,1615lm,2153lm, 2692lm  
L90 B10=50,000h  
2700K, 3000K, 3500K,4000K  
CRI>90

Lengths: 5.4W/11.3", 10.8W/22.3", 16.2W/33.3", 21.6W/44.4", 27W/55.4"  
Lumen delivered up to 368lm,755lm,1133lm,1509lm,1888lm  
L90 B10=50,000h  
2700K,3000K, 3500K, 4000K  
CRI>90

Lengths: 4.3W/11.3", 8.6W/22.3", 12.9W/33.4", 15.4W/44.4"  
Lumen delivered up to 546lm,1093lm,1640lm,1968lm  
L90 B10=50,000h  
2700K, 3000K, 3500K,4000K  
CRI>90

High-Performance  
lengths: 9.9W/11.3", 15W/11.3"  
Lumen delivered up to 1081lm,1506 lm  
L90 B10=50,000h  
2700K, 3000K, 3500K,4000K  
CRI>90

- Watt lumen data refer to nominal values of the LED source, for photometric data visit [www.reggianiusa.com](http://www.reggianiusa.com).  
- For 3500K, must consult with factory to confirm availability



# Worldwide contacts

## USA

Reggiani Lighting USA, inc.  
372 Starke Road  
Carlstadt NJ 07072, USA  
T. (+1) 201 372 1717  
F. (+1) 201 372 1616  
info@reggianiusa.com  
www.reggianiusa.com

## HEADQUARTERS

### ITALY

Reggiani Spa Illuminazione  
Viale Monza 16 P.O. Box 99  
20845 Sovico (MB), Italy  
T. (+39) 039 20711  
F. (+39) 039 2071999  
contact@reggiani.net

## CHINA

Reggiani Ningbo ITG Lighting co. Ltd  
Shenjia Village - Qiuai Town - Yinzhou  
315010 Ningbo, China  
T. (+86) 574 88418655 - 88412627  
F. (+86) 574 88364186  
info@itglight.com

## UNITED KINGDOM

Reggiani Ltd  
12 Chester Road  
Borehamwood  
Herts, WD6 1LT - UK  
T. (+44) 0208 236 3000  
F. (+44) 0208 236 3099  
reggiani@reggiani.co.uk

## RUSSIA

## Showroom

Kalanchevskaya Street, 16,  
Building 1, Room 4A, 129090 Moscow  
T. (+7) 495 2690113 - 846 3320266  
F. (+7) 495 2690112  
russia@reggiani.net

## FRANCE

### Showroom

Showroom Bureau Projets  
35 Bd. Richard Lenoir, Bastille  
75011 Paris, France  
T. (+33) 01 43382704  
F. (+33) 01 43382720  
france@reggiani.net

## Worldwide distributors

For the worldwide distributors list visit  
www.reggianiusa.com



