

An ultra-miniaturized system that seamlessly fits into every architectural space. Shape your ideal layout.

OUTLINE

24V System

Reggiani

Reggiani

Contents

| | |
|----------------------------------|----|
| Yori Outline 24V | 17 |
| Yori Outline 24V - Zoom | 35 |
| Yori Pendant Outline 24V | 47 |
| Incline Outline 24V - Adjustable | 67 |
| Linear Outline 24V | 83 |
| Track Outline 24V | 91 |





EN Ultra-miniaturization, thin dimensions and minimal design: Outline is the new micro 24V track system that houses projectors, pendants and linear lighting solutions, in only 11mm.

IT Ultra miniaturizzazione, dimensioni ridotte e design minimale: Outline è il nuovo sistema a 24V che può ospitare proiettori, soluzioni di illuminazione a sospensione e lineari, in soli 11mm di larghezza.



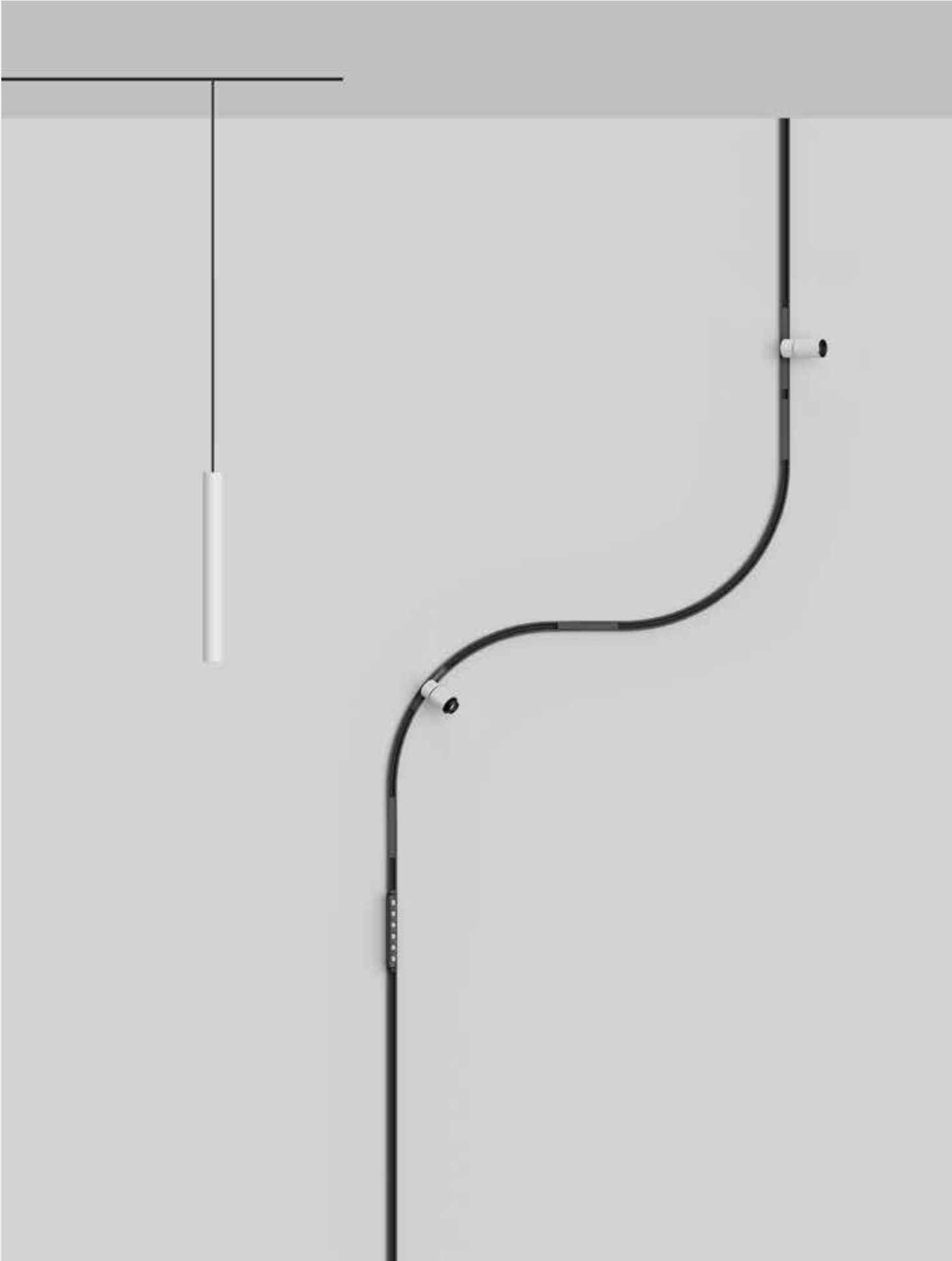

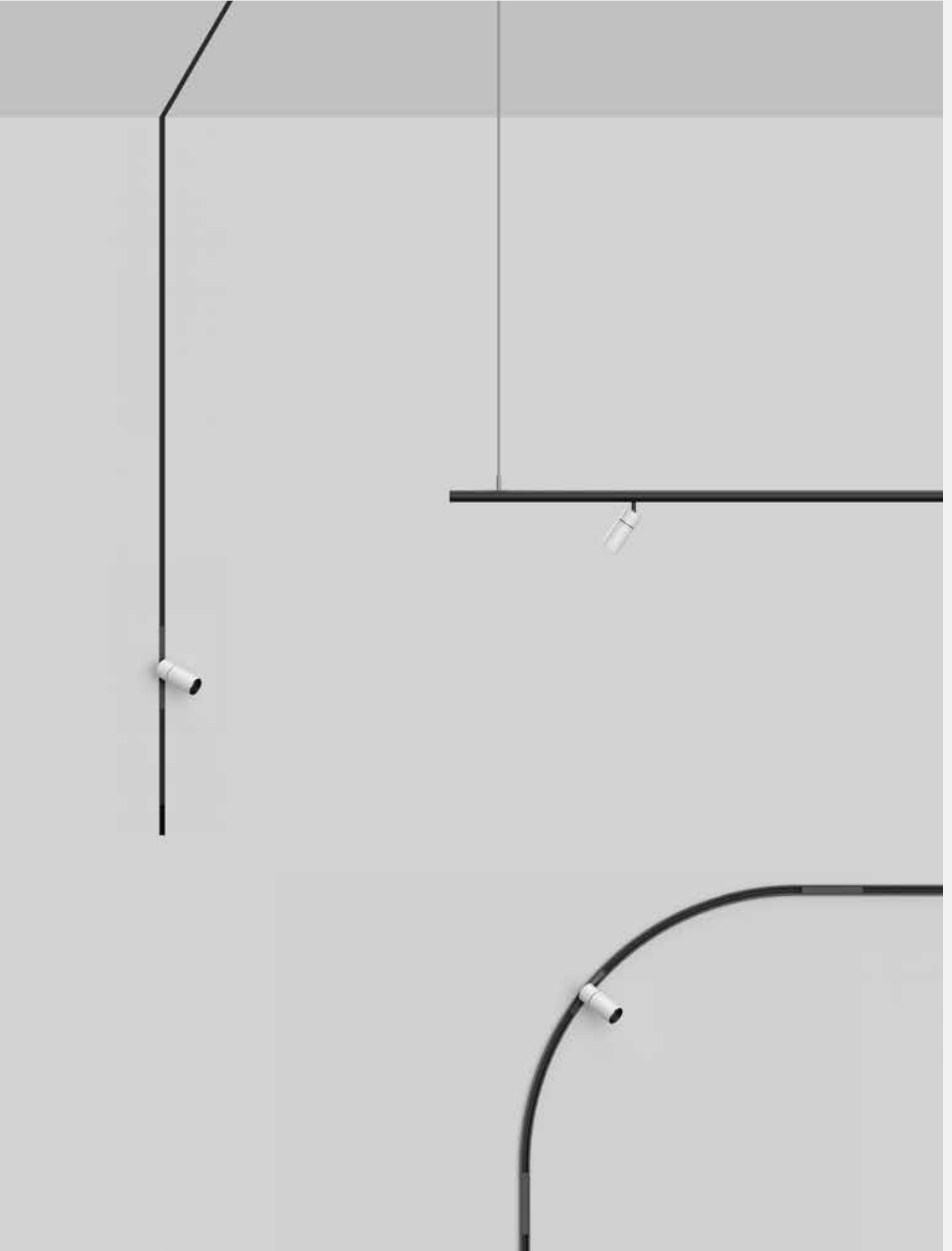









Choose your favourite





Yori Outline 24V
p.17

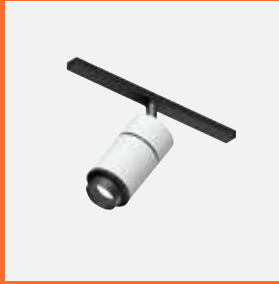

Yori Outline 24V - Zoom
p.35

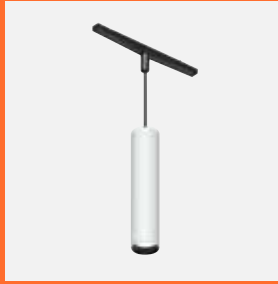

Yori Pendant Outline 24V
p.47



Incline Outline 24V - Adjustable
p.67



Linear Outline 24V
p.83

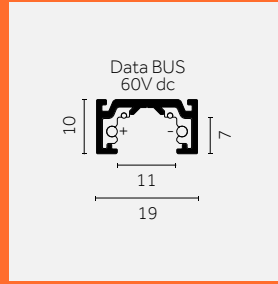

Track Outline 24V
p.91















Yori Outline 24V



EN Yori Outline is an ultra-miniaturized, high performance projector specifically developed for Outline 24V system. The projector keeps the characteristics of minimal design, refined finishes and excellent lighting results typical of the Yori Family. Yori Outline 24V can be mounted on linear and curved segments, thanks to its 7mm adapter which disappears completely inside the track, giving extreme freedom of application. Yori Outline 24V is available in three color temperatures, 2700K, 3000K and 4000K, all with CRI>90 which assures excellent color rendition.

IT Yori Outline 24V è il proiettore ultra-miniaturizzato, ad elevate prestazioni, sviluppato specificatamente per il sistema Outline 24V. Il proiettore mantiene le caratteristiche di design minimale, finiture ricercate e risultati illuminotecnici eccellenti tipici della famiglia Yori. Yori Outline 24V può essere installato sia su segmenti lineari che curvi, grazie all'adattatore di 7mm che scompare completamente all'interno del binario. Questo permette un'estrema libertà di applicazione. Yori Outline 24V è disponibile in tre temperature colore, 2700K, 3000K e 4000K, e CRI>90 per garantire un'ottima resa cromatica.

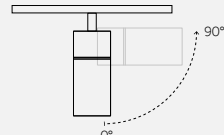
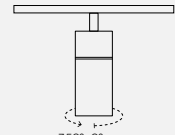

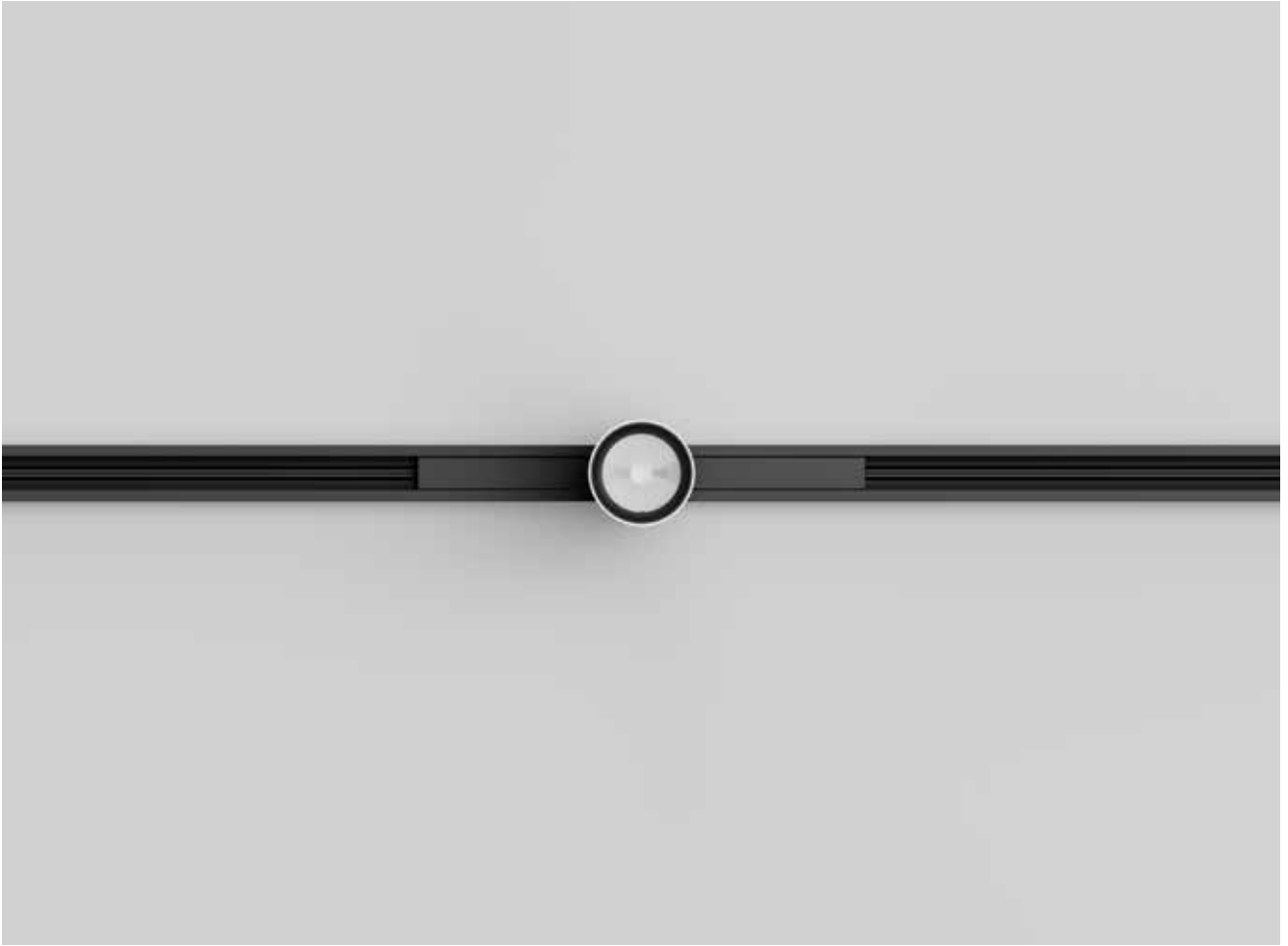
| | | | |
|-----------------------------------------------------------------------------------------------|---------------------------------------------------------------------------------------------------------------------------------------------------------------------------------------------------------------------------------------------------------------------------------------------------------------------------------------------------------------------------------------------------------------------------------------------------------------------------------------------------------------------------------------------------------------------------------------------------------|-----------------------------------------------------------------------------------------------------------------------------------------------------------------------------------------------------------------------------------------------------------------------------------------------------------------------------------------------------------------------------------------------------------------------------------------------------------------------------------------------------------------------------------------------------------------------------------------------------------------|--------------------------------------------------------------------------------------------------------------------------------------------------------------------------------------------------------------------------------------------------------------------------------------------------------------------------------------------------------------------------------------------------------------------------------------------------------------------------------------|
| <p>Versions/ Versioni</p> | | | |
| <p>Yori Outline 24V</p> |  <p>Yori Outline 24V</p> |  <p>Yori Outline 24V - Curved</p> | |
| <p>Finishes/ Finiture</p> <p>Special finishes/ Finiture speciali</p> |  <p>12 Embossed matte white/ Bianco opaco goffrato</p>  <p>01 Chrome/ Cromo</p>  <p>D0 Brushed brass/ Ottone spazzolato</p>  <p>M0 Brushed aluminium/ Alluminio spazzolato</p> |  <p>31 Embossed matte black/ Nero opaco goffrato</p>  <p>B0 Royal matte black/ Nero opaco royal</p>  <p>E0 Brushed gold/ Oro spazzolato</p>  <p>N0 Brushed copper/ Rame spazzolato</p> |  <p>C0 Royal matte white/ Bianco opaco royal</p>  <p>L0 Antiqued brushed bronze/ Bronzo antico spazzolato</p>  <p>T1 Anodized Bronze/ Bronzo Anodizzato</p> |
| <p>Adjustability/ Orientabilità</p> |  <p>Horizontal axis/ Asse orizzontale</p>  <p>Vertical axis/ Asse verticale</p> | | |
| <p>IP</p> | <p>20</p> | | |
| <p>Control systems</p> | <p>On/Off, DALI</p> | | |
| <p>Insulation class</p> | <p>◆</p> | | |
| <p>Certifications</p> | <p>CE UK ENEC</p> | | |

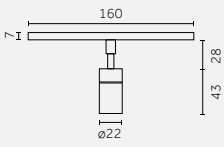
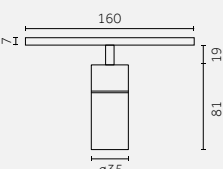
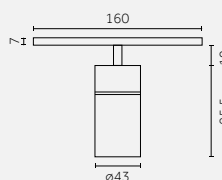
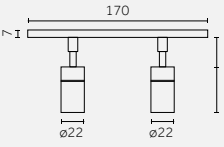
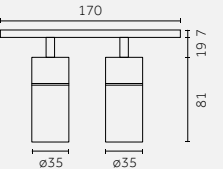
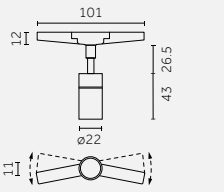
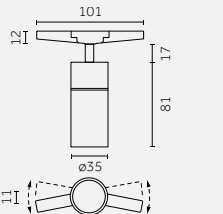
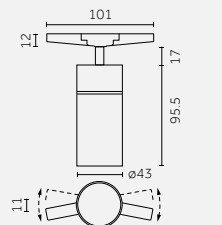

| | Ø 22 mm | Ø 35 mm | Ø 43 mm |
|-------------------------------------------------------------------------------------|-------------------------------------------------------------------------------------------------------------------------------------------------------------------------------------------------|-----------------------------------------------------------------------------------------------------------------------------------------------------------------------------------------------------------|-------------------------------------------------------------------------------------------------------------------------------------------------------------------------------------------------------------------------------------------------------------------------|
| Yori Outline 24V |  <p>p.28</p> |  <p>p.29</p> |  <p>p.30</p> |
| Yori Outline 24V 2X |  <p>p.28</p> |  <p>p.29</p> | |
| Yori Outline 24V Curved |  <p>p.28</p> |  <p>p.30</p> |  <p>p.31</p> |
|  | <p>Narrow (10°) Medium (28°) Wide (33°)</p> | <p>Narrow (11°) Medium (26°) Wide (33°)</p> | <p>Very narrow (8°) Narrow (16°) Medium (23°) Wide (34°)</p> |
| Light source/ Sorgente luminosa | <p>POWER LED 2 W 245 lm - 286 lm L90 B10=50,000 h 2700 K; 3000 K; 4000 K SDCM <3 CRI >90</p> <p>2000 K; 2200 K; 2500K; 3500K with accessories p.32</p> | <p>POWER LED 3,5 W; 7 W 357 lm - 722 lm L90 B10=50,000 h 2700 K; 3000 K; 4000 K SDCM <3 CRI >90</p> <p>2000 K; 2200 K; 2500K; 3500K with accessories p.32-33</p> | <p>POWER LED 5 W; 9 W* 550 lm - 1186 lm L90 B10=50,000 h 2700 K; 3000 K; 4000 K SDCM <3 CRI >90</p> <p>2000 K; 2200 K; 2500K; 3500K with accessories p.33</p> <p>*On request: QT (Tunable white) DT (Warm Dimming)</p> |

EN Ultra-miniaturization for a seamless result. The 10mm track height guarantees cleanliness and simplicity, providing the ability to imitate a recessed effect without complicated ceiling details.

IT Ultra miniaturizzazione per un risultato impeccabile. L'altezza del binario di soli 10mm garantisce pulizia e semplicità: ciò permette di ricreare effetti ad incasso senza lavorare sul controsoffitto.

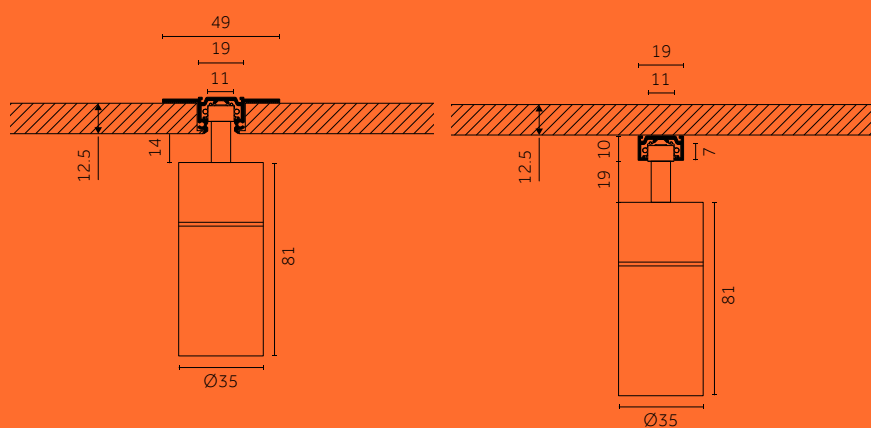

EN Yori Outline 24V mounted on recessed track.

IT Yori Outline 24V installato su binario ad incasso.

EN Yori Outline 24V mounted on surface track.

IT Yori Outline 24V installato su binario a superficie.



Play with the curves

EN To shape the ideal layout, the curved adapter, developed especially for our Outline system, allows the installation of Yori projectors on curved track. Choose between the 300mm and 500mm radii that best suits your configuration. Yori Outline 24V with curved adapter is available in Ø22mm, Ø35mm, Ø43mm.

IT Per permettere la creazione del layout ideale, l'adattatore curvo, sviluppato specificatamente per il sistema Outline, permette l'installazione del proiettore su binari curvi. Scegli il raggio che più si adatta alla tua configurazione (300mm, 500mm). Yori Outline 24V con adattatore curvo è disponibile per i diametri Ø22mm, Ø35mm, Ø43mm.



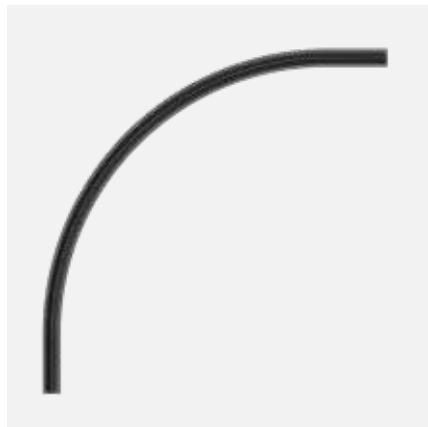
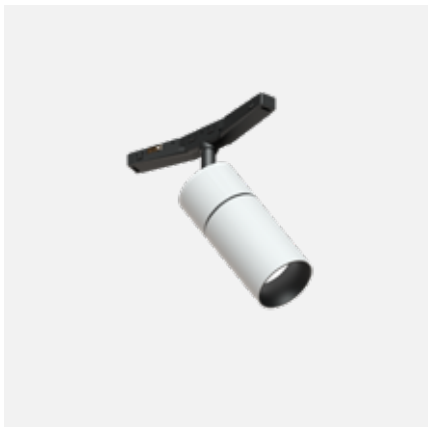

EN Curved adapter available for Yori Outline 24V.
 IT Adattatore curvo disponibile per Yori Outline 24V.

EN Curved section of the track.
 IT Sezione curva del binario.

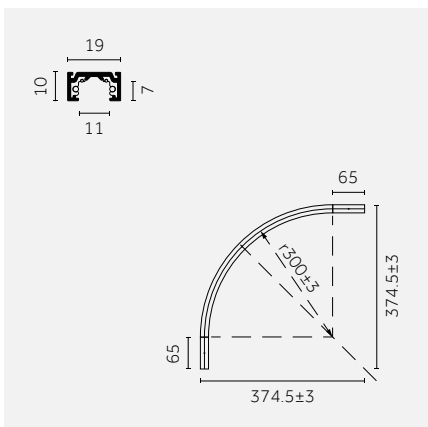

EN 300mm r curve.
 IT Curva raggio 300mm.

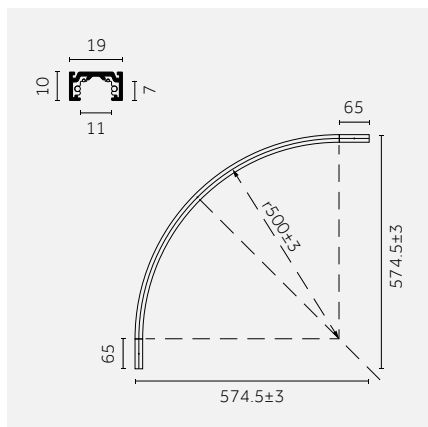

EN 500mm r curve.
 IT Curva raggio 500mm.

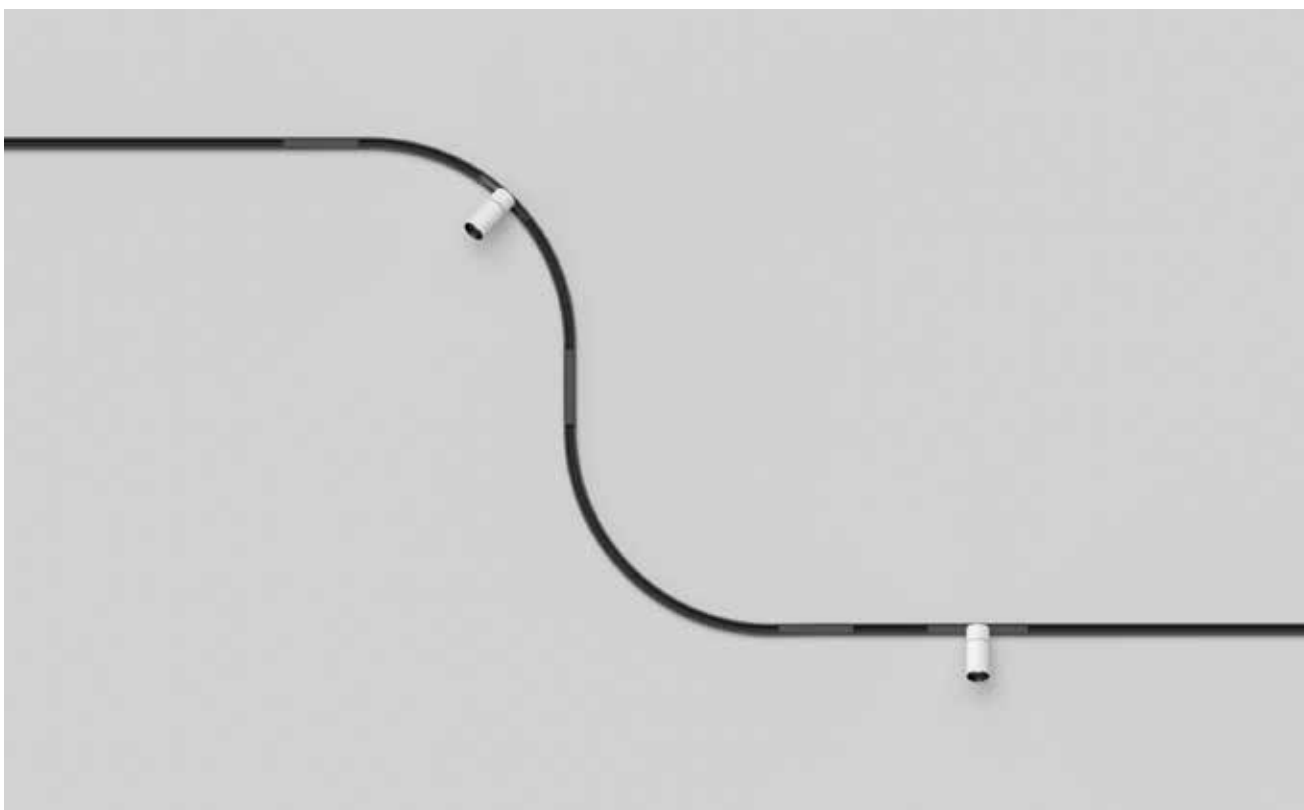

A quality light



^{EN} Optic is positioned further back from external protective glass to allow maximum glare control regardless of the use of any accessory.

^{IT} L'ottica arretrata rispetto al vetro di protezione esterno consente alto controllo dell'abbaglio anche senza alcun accessorio.

^{EN} LED with CRI>90 making the whole range suitable for high-end applications.

^{IT} LED con CRI>90 disponibile per tutto il sistema, per garantire luce di qualità.

EN Yori Outline 24V is available with a range of integrated accessories: from selective filters to modify the color temperature, to colored filters for optional light effects. Spread lens, honeycomb and anti-glare screens complete the range. The concentric circles antiglare accessory can be used on narrow beams light fixtures to reduce glare and focus the light beam.

IT Yori Outline 24V è disponibile con differenti accessori integrati: dai filtri selettivi per variare la temperatura colore, ai filtri colorati per opzionali effetti di luce. Lente diffondente, schermi alveolari e antiglare completano la gamma. L'accessorio antiglare a cerchi concentrici può essere utilizzato sui fasci stretti per ridurre l'abbagliamento e concentrare il fascio.

EN Colored filters
IT Filtri colorati

EN Selective filters
IT Filtri selettivi

EN Honeycomb and spread lens
IT Griglia alveolare e lente diffondente

EN Cerchi concentrici
IT Concentric circles

EN Antiglare
IT Antiglare



EN Yori with antiglare concentric circles accessory.
IT Yori con accessorio antiglare a cerchi concentrici.



EN The antiglare concentric circles accessory creates a focused light beam, ideal for shop windows.
IT L'accessorio antiglare a cerchi concentrici crea un fascio di luce concentrato, ideale per vetrine.

Ø 22 mm | Precision

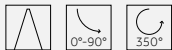
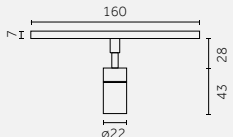

Code example:
0 - **BS41** **B** - **HW** **12**

Accessories: p. 32
 Track Outline 24V: p.91-108
 Finishes: p.56-57
 Photometric data:
 www.reggiani.net

Notes:
 2000K; 2200K; 2500K; 3500K
 with accessories p.32

| 2 W | | POWER LED | | Lumen delivered up to 87 lm / Lumen maintenance: L90 B10=50,000h | | | | | | |
|-------------------|----------------------|---------------------|-----------|------------------------------------------------------------------|-----|-----|------|-----------|--|--|
| Driver | Version | Optics | LED | K | CRI | lm | SDCM | Finishes | | |
| 0 On-Off | BS41 Standard | B 10° Narrow | HW | 2700 | >90 | 245 | <3 | 12 | | |
| D DALI | | E 28° Medium | HQ | 3000 | >90 | 264 | <3 | 31 | | |
| | | H 33° Wide | HN | 4000 | >90 | 286 | <3 | 01 | | |
| LED nominal lumen | | | | | | | | | | |
| | | | | | | | | B0 | | |
| | | | | | | | | C0 | | |
| | | | | | | | | D0 | | |
| | | | | | | | | E0 | | |
| | | | | | | | | L0 | | |
| | | | | | | | | M0 | | |
| | | | | | | | | N0 | | |
| | | | | | | | | T1 | | |

Ø 22 mm | Precision 2X

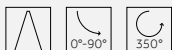
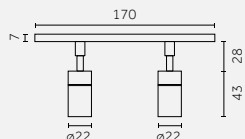

Code example:
0 - **FS41** **B** - **HW** **12**

Accessories: p. 32
 Track Outline 24V: p.91-108
 Finishes: p.56-57
 Photometric data:
 www.reggiani.net

Notes:
 2000K; 2200K; 2500K; 3500K
 with accessories p.32

| 2x2 W | | POWER LED | | Lumen delivered up to 2x87 lm / Lumen maintenance: L90 B10=50,000h | | | | | | |
|-------------------|----------------------|---------------------|-----------|--------------------------------------------------------------------|-----|-------|------|-----------|--|--|
| Driver | Version | Optics | LED | K | CRI | lm | SDCM | Finishes | | |
| 0 On-Off | FS41 Standard | B 10° Narrow | HW | 2700 | >90 | 2x245 | <3 | 12 | | |
| D DALI | | E 28° Medium | HQ | 3000 | >90 | 2x264 | <3 | 31 | | |
| | | H 33° Wide | HN | 4000 | >90 | 2x286 | <3 | 01 | | |
| LED nominal lumen | | | | | | | | | | |
| | | | | | | | | B0 | | |
| | | | | | | | | C0 | | |
| | | | | | | | | D0 | | |
| | | | | | | | | E0 | | |
| | | | | | | | | L0 | | |
| | | | | | | | | M0 | | |
| | | | | | | | | N0 | | |
| | | | | | | | | T1 | | |

Ø 22 mm | Precision Curved

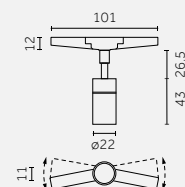
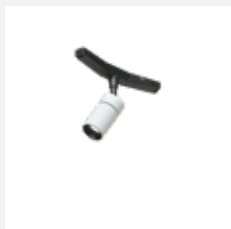

Code example:
0 - **BS61** **B** - **HW** **12**

Accessories: p. 32
 Track Outline 24V: p.91-108
 Finishes: p.56-57
 Photometric data:
 www.reggiani.net

Notes:
 2000K; 2200K; 2500K; 3500K
 with accessories p.32

| 2 W | | POWER LED | | Lumen delivered up to 87 lm / Lumen maintenance: L90 B10=50,000h | | | | | | |
|-------------------|--------------------|---------------------|-----------|------------------------------------------------------------------|-----|-----|------|-----------|--|--|
| Driver | Version | Optics | LED | K | CRI | lm | SDCM | Finishes | | |
| 0 On-Off | BS61 Curved | B 10° Narrow | HW | 2700 | >90 | 245 | <3 | 12 | | |
| | | E 28° Medium | HQ | 3000 | >90 | 264 | <3 | 31 | | |
| | | H 33° Wide | HN | 4000 | >90 | 286 | <3 | 01 | | |
| LED nominal lumen | | | | | | | | | | |
| | | | | | | | | B0 | | |
| | | | | | | | | C0 | | |
| | | | | | | | | D0 | | |
| | | | | | | | | E0 | | |
| | | | | | | | | L0 | | |
| | | | | | | | | M0 | | |
| | | | | | | | | N0 | | |
| | | | | | | | | T1 | | |

Ø 35 mm | Precision

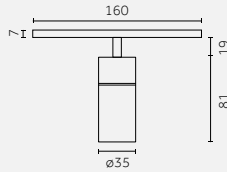

Code example:

0 . **LS41** **B** . **HW** **12**

Accessories: p.32-33

Track Outline 24V: p.91-108

Finishes: p.56-57

Photometric data:

www.reggiani.net

Notes:

2000 K; 2200 K; 2500K; 3500K
with accessories p.32-33

3.5 W POWER LED Lumen delivered up to 282 lm / Lumen maintenance: L90 B10=50,000h

| Driver | Version | Optics | LED | K | CRI | lm | SDCM | Finishes |
|-------------------|----------------------|---------------------|-----------|------|-----|-----|------|-----------|
| 0 On-Off | LS41 Standard | B 11° Narrow | HW | 2700 | >90 | 355 | <3 | 12 |
| D DALI | | E 26° Medium | HQ | 3000 | >90 | 376 | <3 | 31 |
| | | H 33° Wide | HN | 4000 | >90 | 405 | <3 | 01 |
| LED nominal lumen | | | | | | | | B0 |
| | | | | | | | | C0 |
| | | | | | | | | D0 |
| | | | | | | | | E0 |
| | | | | | | | | L0 |
| | | | | | | | | M0 |
| | | | | | | | | N0 |
| | | | | | | | | T1 |

7 W POWER LED Lumen delivered up to 565 lm / Lumen maintenance: L90 B10=50,000h

| Driver | Version | Optics | LED | K | CRI | lm | SDCM | Finishes |
|-------------------|----------------------|---------------------|-----------|------|-----|-----|------|-----------|
| 0 On-Off | LS42 Standard | B 11° Narrow | HW | 2700 | >90 | 635 | <3 | 12 |
| D DALI | | E 26° Medium | HQ | 3000 | >90 | 669 | <3 | 31 |
| | | H 33° Wide | HN | 4000 | >90 | 720 | <3 | B0 |
| LED nominal lumen | | | | | | | | C0 |
| | | | | | | | | D0 |
| | | | | | | | | E0 |
| | | | | | | | | L0 |
| | | | | | | | | M0 |
| | | | | | | | | N0 |
| | | | | | | | | T1 |

Ø 35 mm | Precision 2X

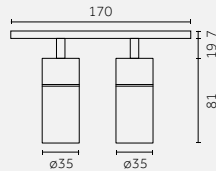

Code example:

0 . **HS42** **B** . **HW** **12**

Accessories: p.32-33

Track Outline 24V: p.91-108

Finishes: p.56-57

Photometric data:

www.reggiani.net

Notes:

2000 K; 2200 K; 2500K; 3500K
with accessories p.32-33

2x3.5 W POWER LED Lumen delivered up to 2x282 lm / Lumen maintenance: L90 B10=50,000h

| Driver | Version | Optics | LED | K | CRI | lm | SDCM | Finishes |
|-------------------|----------------------|---------------------|-----------|------|-----|-------|------|-----------|
| 0 On-Off | HS42 Standard | B 11° Narrow | HW | 2700 | >90 | 2x355 | <3 | 12 |
| D DALI | | E 26° Medium | HQ | 3000 | >90 | 2x376 | <3 | 31 |
| | | H 33° Wide | HN | 4000 | >90 | 2x405 | <3 | 01 |
| LED nominal lumen | | | | | | | | B0 |
| | | | | | | | | C0 |
| | | | | | | | | D0 |
| | | | | | | | | E0 |
| | | | | | | | | L0 |
| | | | | | | | | M0 |
| | | | | | | | | N0 |
| | | | | | | | | T1 |

Ø 35 mm | Precision Curved

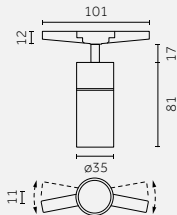
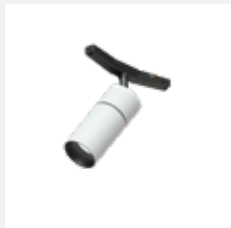

Code example:
0 . **LS61** . **B** . **HW** **12**

Accessories: p. 32-33
 Track Outline 24V: p.91-108
 Finishes: p.56-57

Photometric data:
www.reggiani.net

Notes:
 2000K; 2200K; 2500K; 3500K
 with accessories p.32-33

| 3.5 W POWERLED | | Lumen delivered up to 282lm / Lumen maintenance: L90 B10=50,000h | | | | | | | Finishes | |
|-----------------|--------------------|------------------------------------------------------------------|-------------------|------|-----|-----|------|-----------|----------|--|
| Driver | Version | Optics | LED | K | CRI | lm | SDCM | | | |
| 0 On-Off | LS61 Curved | B 11° Narrow | HW | 2700 | >90 | 355 | <3 | 12 | | |
| | | E 26° Medium | HQ | 3000 | >90 | 375 | <3 | 31 | | |
| | | H 33° Wide | HN | 4000 | >90 | 405 | <3 | 01 | | |
| | | | LED nominal lumen | | | | | B0 | | |
| | | | | | | | | C0 | | |
| | | | | | | | | D0 | | |
| | | | | | | | | E0 | | |
| | | | | | | | | L0 | | |
| | | | | | | | | M0 | | |
| | | | | | | | | N0 | | |
| | | | | | | | | T1 | | |

| 7 W POWERLED | | Lumen delivered up to 565lm / Lumen maintenance: L90 B10=50,000h | | | | | | | Finishes | |
|-----------------|--------------------|------------------------------------------------------------------|-------------------|------|-----|-----|------|-----------|----------|--|
| Driver | Version | Optics | LED | K | CRI | lm | SDCM | | | |
| 0 On-Off | LS62 Curved | B 11° Narrow | HW | 2700 | >90 | 635 | <3 | 12 | | |
| | | E 26° Medium | HQ | 3000 | >90 | 670 | <3 | 31 | | |
| | | H 33° Wide | HN | 4000 | >90 | 720 | <3 | B0 | | |
| | | | LED nominal lumen | | | | | C0 | | |
| | | | | | | | | D0 | | |
| | | | | | | | | E0 | | |
| | | | | | | | | L0 | | |
| | | | | | | | | M0 | | |
| | | | | | | | | N0 | | |
| | | | | | | | | T1 | | |

Ø 43 mm | Precision

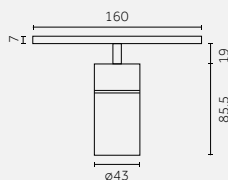

Code example:
0 . **MS42** . **A** . **HW** **12**

Accessories: p. 33
 Track Outline 24V: p.91-108
 Finishes: p.56-57

Photometric data:
www.reggiani.net

Notes:
 2000K; 2200K; 2500K; 3500K
 with accessories p.33

| 5 W POWERLED | | Lumen delivered up to 535lm / Lumen maintenance: L90 B10=50,000h | | | | | | | Finishes | |
|-----------------|----------------------|------------------------------------------------------------------|-------------------------------|------|-----|-----|------|-----------|----------|--|
| Driver | Version | Optics | LED | K | CRI | lm | SDCM | | | |
| 0 On-Off | MS42 Standard | A 8° Very narrow | HW | 2700 | >90 | 550 | <3 | 12 | | |
| D DALI | | B 16° Narrow | HQ | 3000 | >90 | 594 | <3 | 31 | | |
| | | E 23° Medium | HN | 4000 | >90 | 640 | <3 | 01 | | |
| | | H 34° Wide | LED nominal lumen | | | | | B0 | | |
| | | | QT (Tunable white) on request | | | | | C0 | | |
| | | | DT (Warm Dimming) on request | | | | | D0 | | |
| | | | | | | | | E0 | | |
| | | | | | | | | L0 | | |
| | | | | | | | | M0 | | |
| | | | | | | | | N0 | | |
| | | | | | | | | T1 | | |

| 9 W POWERLED | | Lumen delivered up to 1070lm / Lumen maintenance: L90 B10=50,000h | | | | | | | Finishes | |
|-----------------|----------------------|-------------------------------------------------------------------|-------------------------------|------|-----|------|------|-----------|----------|--|
| Driver | Version | Optics | LED | K | CRI | lm | SDCM | | | |
| 0 On-Off | MS43 Standard | A 8° Very narrow | HW | 2700 | >90 | 1027 | <3 | 12 | | |
| D DALI | | B 16° Narrow | HQ | 3000 | >90 | 1101 | <3 | 31 | | |
| | | E 23° Medium | HN | 4000 | >90 | 1186 | <3 | B0 | | |
| | | H 34° Wide | LED nominal lumen | | | | | C0 | | |
| | | | QT (Tunable white) on request | | | | | D0 | | |
| | | | DT (Warm Dimming) on request | | | | | E0 | | |
| | | | | | | | | L0 | | |
| | | | | | | | | M0 | | |
| | | | | | | | | N0 | | |
| | | | | | | | | T1 | | |

Ø 43 mm | Precision Curved

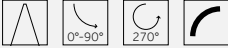
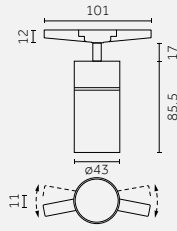

Code example:

0 - MS62 A - HW 12

Accessories: p. 33

Track Outline 24V: p.91-108

Finishes: p.56-57

Photometric data:

www.reggiani.net

Notes:

2000K; 2200K; 2500K; 3500K
with accessories p.33







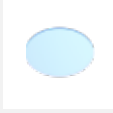

| 5 W POWER LED | | Lumen delivered up to 535lm / Lumen maintenance: L90 B10=50,000h | | | | | | | |
|---------------|---------------|------------------------------------------------------------------|-------------------|------|-----|-----|------|----------|--|
| Driver | Version | Optics | LED | K | CRI | lm | SDCM | Finishes | |
| 0 On-Off | MS62 Standard | A 8° Very narrow | HW | 2700 | >90 | 550 | <3 | 12 | |
| | | B 16° Narrow | HQ | 3000 | >90 | 594 | <3 | 31 | |
| | | E 23° Medium | HN | 4000 | >90 | 640 | <3 | 01 | |
| | | H 34° Wide | LED nominal lumen | | | | | B0 | |
| | | | | | | | | C0 | |
| | | | | | | | | D0 | |
| | | | | | | | | E0 | |
| | | | | | | | | L0 | |
| | | | | | | | | M0 | |
| | | | | | | | | N0 | |
| | | | | | | | | T1 | |

| 9 W POWER LED | | Lumen delivered up to 1070 lm / Lumen maintenance: L90 B10=50,000h | | | | | | | |
|---------------|---------------|--------------------------------------------------------------------|-------------------|------|-----|------|------|----------|--|
| Driver | Version | Optics | LED | K | CRI | lm | SDCM | Finishes | |
| 0 On-Off | MS63 Standard | A 8° Very narrow | HW | 2700 | >90 | 1027 | <3 | 12 | |
| | | B 16° Narrow | HQ | 3000 | >90 | 1101 | <3 | 31 | |
| | | E 23° Medium | HN | 4000 | >90 | 1186 | <3 | B0 | |
| | | H 34° Wide | LED nominal lumen | | | | | C0 | |
| | | | | | | | | D0 | |
| | | | | | | | | E0 | |
| | | | | | | | | L0 | |
| | | | | | | | | M0 | |
| | | | | | | | | N0 | |
| | | | | | | | | T1 | |

Accessories





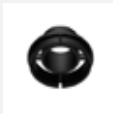



Yori Outline 24V | Ø 22 mm | Precision



Optics accessories/ Accessori ottiche

| Description | Code | Finishes | Description | Code | Finishes |
|---------------------------------------------------------------------------------------------------------------------------------------------------------------------------|-------------------|--------------------------------------------------------------------------------------------------------------|----------------------------------------------------------------------------------------------------------------------------------------------------------------------------------------|-------------------|-----------|
|  Colored glass filter 1 mm/ Filtro in vetro colorato 1 mm Holder included | 0.26700.00 | 4A Red 5A Green 6A Blue 7A Pink 8A Yellow 9A Orange |  Selective filter 3000K - 3500K / Filtro selettivo 3000K - 3500K Holder included | 0.26705.00 | |
|  Selective filter 3000K - 2700K / Filtro selettivo 3000K - 2700K Holder included | 0.26701.00 | |  Elliptical beam lens / Lente per fascio ellittico Holder included | 0.26707.00 | |
|  Selective filter 2700K - 2500K / Filtro selettivo 2700K - 2500K Holder included | 0.26702.00 | |  Opal lens / Lente opale Holder included | 0.26708.00 | |
|  Selective filter 2700K - 2200K / Filtro selettivo 2700K - 2200K Holder included | 0.26703.00 | |  Spread lens / Lente diffondente Holder included | 0.26709.00 | |
|  Selective filter 2700K - 2000K / Filtro selettivo 2700K - 2000K Holder included | 0.26704.00 | |  Concentric circles / Cerchi concentrici Only for light beam B / Solo per fascio di luce B | 0.26582.00 | 31 |

Yori Outline 24V | Ø 35 mm | Precision





























Optics accessories/ Accessori ottiche

| Description | Code | Finishes | Description | Code | Finishes |
|---------------------------------------------------------------------------------------------------------------------------------------------------------------------------|-------------------|--------------------------------------------------------------------------------------------------------------|---------------------------------------------------------------------------------------------------------------------------------------------------------------------------|-------------------|----------|
|  Colored glass filter 1 mm / Filtro in vetro colorato 1 mm Holder included | 0.26710.00 | 4A Red 5A Green 6A Blue 7A Pink 8A Yellow 9A Orange |  Selective filter 2700K - 2000K / Filtro selettivo 2700K - 2000K Holder included | 0.26714.00 | |
|  Selective filter 3000K - 2700K / Filtro selettivo 3000K - 2700K Holder included | 0.26711.00 | |  Selective filter 3000K - 3500K / Filtro selettivo 3000K - 3500K Holder included | 0.26715.00 | |
|  Selective filter 3000K - 4000K / Filtro selettivo 3000K - 4000K Holder included | 0.26712.00 | |  Elliptical beam lens / Lente per fascio ellittico Holder included | 0.26716.00 | |
|  Selective filter 2700K - 2200K / Filtro selettivo 2700K - 2200K Holder included | 0.26713.00 | |  Opal lens / Lente opale Holder included | 0.26717.00 | |
| | | |  Opal lens / Lente opale Holder included | 0.26718.00 | |

| | | | | | | |
|-----------------------------------------------------------------------------------|------------------------------------------------------------------------------------------------------------------------|----------------------------------|---------------------------------------------------------------------------------------------------------|-----------------------------------------------------------------------------------|--------------------------------------------------------------------------------------------------------------|------------------------------------|
|  | Description Spread lens/ Lente diffondente Holder included | Code <u>0.26719.00</u> | |  | Description Dense texture honeycomb louvre/ Griglia alveolare a maglia fitta Holder included | Code <u>0.26398.0000</u> |
|  | Description Concentric circles/ Cerchi concentrici Only for light beam B/ Solo per fascio di luce B | Code <u>0.26583.00</u> | Finishes 31  |  | Description Wide texture honeycomb louvre/ Griglia alveolare a maglia larga Holder included | Code <u>0.26399.0000</u> |

Yori Outline 24V | Ø 43 mm | Precision

Optics accessories/ Accessori ottiche

| | | | | | | | |
|-------------------------------------------------------------------------------------|---------------------------------------------------------------------------------------------------------------|------------------------------------|---------------------------------------------------------------------------------------------------------------------------------------------------------------------------------------------------------------------------------------------------------------------------------------------------------------------------------------------------------------------------------------------------------------------------------------------------------------------------------------------------------------------------------------------------------------------------------------------------|-------------------------------------------------------------------------------------|----------------------------------------------------------------------------------------------------------------------------------|------------------------------------|---------------------------------------------------------------------------------------------------------------------------------------------------------------------------------------------------------|
|  | Description Colored glass filter 1 mm/ Filtro in vetro colorato 1 mm Holder included | Code <u>0.26400.00</u> | Finishes 4A Red  5A Green  6A Blue  7A Pink  8A Yellow  9A Orange  |  | Description Wide texture honeycomb louvre/ Griglia alveolare a maglia larga Holder included | Code <u>0.26448.0000</u> | |
|  | Description Elliptical beam lens / Lente per fascio ellittico Holder included | Code <u>0.26456.0000</u> | |  | Description Opal lens/ Lente opale Holder included | Code <u>0.26460.0000</u> | |
|  | Description Colored gel slides (2 pieces)/ Vetrini per gel colorato (2 pezzi) Holder included | Code <u>0.26408.0000</u> | |  | Description Spread lens/ Lente diffondente Holder included | Code <u>0.26468.0000</u> | |
|  | Description Selective filter 3000K - 2700K / Filtro selettivo 3000K - 2700K Holder included | Code <u>0.26557.0000</u> | |  | Description Cross blade louvre/ Griglia a croce Holder included | Code <u>0.26476.0000</u> | |
|  | Description Selective filter 2700K - 2500K / Filtro selettivo 2700K - 2500K Holder included | Code <u>0.26416.0000</u> | |  | Description Barn doors/ Alette rompiflusso Holder included | Code <u>0.26484.0000</u> | |
|  | Description Selective filter 2700K - 2200K / Filtro selettivo 2700K - 2200K Holder included | Code <u>0.26424.0000</u> | |  | Description Cone 45° wall washer/ Cono 45° wall washer Holder included | Code <u>0.26488.00</u> | Finishes 12  31  |
|  | Description Selective filter 2700K - 2000K / Filtro selettivo 2700K - 2000K Holder included | Code <u>0.26432.0000</u> | |  | Description Short snoot / Cilindro corto Holder included | Code <u>0.26556.00</u> | Finishes 12  31  |
|  | Description Selective filter 3000K - 3500K / Filtro selettivo 3000K - 3500K Holder included | Code <u>0.26565.0000</u> | |  | Description Concentric circles/ Cerchi concentrici Only for light beam A and B/ Solo per fascio di luce A e B | Code <u>0.26584.00</u> | Finishes 31  |
|  | Description Selective filter 3000K - 4000K / Filtro selettivo 3000K - 4000K Holder included | Code <u>0.26573.0000</u> | |  | Description Dense texture honeycomb louvre/ Griglia alveolare a maglia fitta Holder included | Code <u>0.26440.0000</u> | |













Yori Outline 24V

Zoom



EN Yori Outline 24V - Zoom is an excellent solution for accent lighting. The knurled ring on the projector allows to adjust the beam angle from 7° to 37° with the same soft and even distribution. Yori Outline 24V Zoom is available in Ø22mm, Ø35mm, Ø43mm.

IT Yori Outline 24V - Zoom è una soluzione eccellente per l'illuminazione d'accento. L'anello zigrinato sul proiettore permette l'aggiustamento del fascio di luce dai 7° ai 37° e conferisce così alla luce una distribuzione morbida ed uniforme. Yori Outline 24V è disponibile in Ø22mm, Ø35mm, Ø43mm.

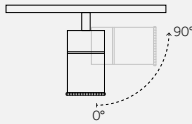
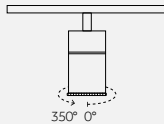

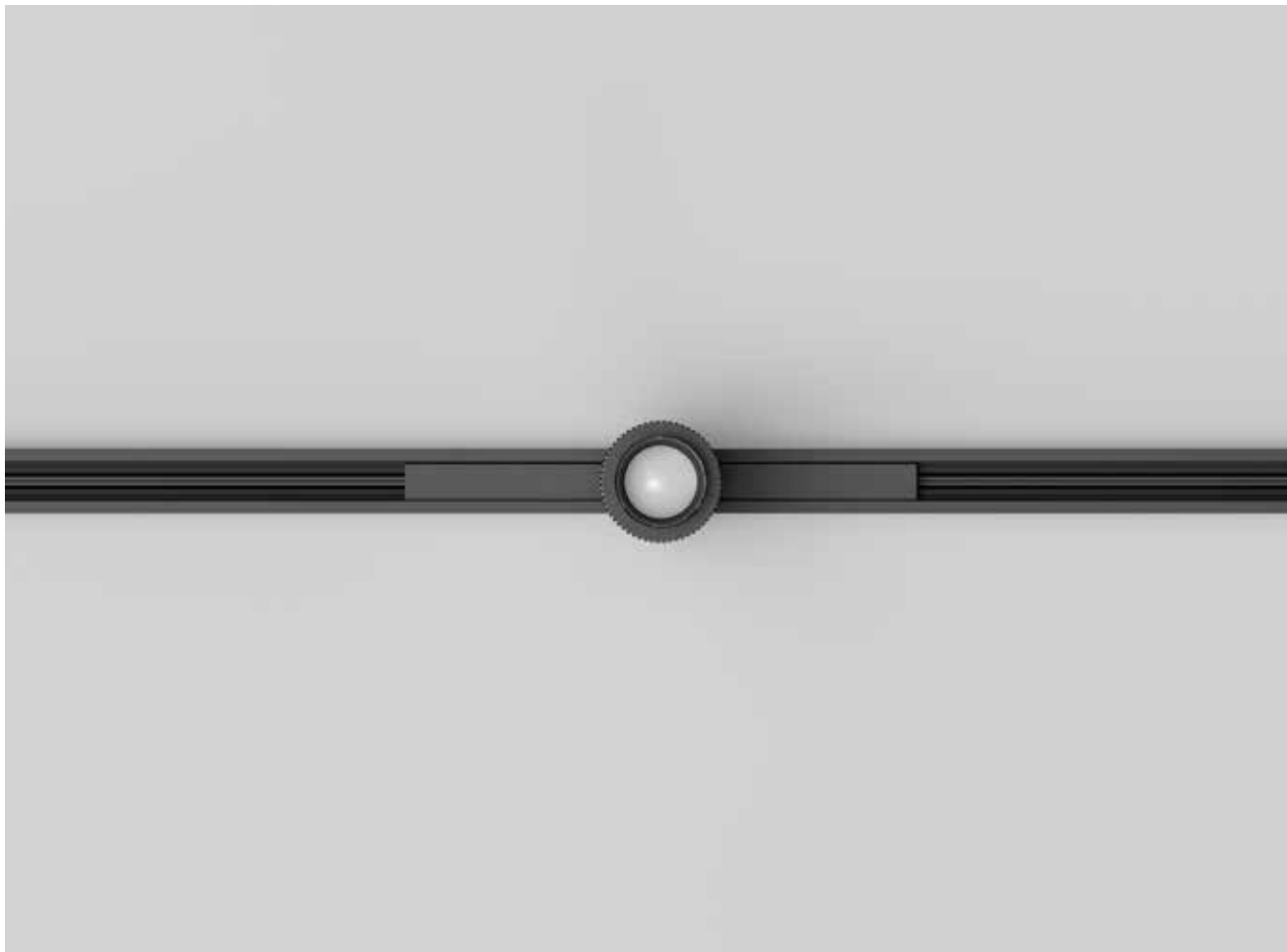
| | | | |
|-----------------------------------------------------------------------------------------------|--------------------------------------------------------------------------------------------------------------------------------------------------------------------------------------------------------------------------------------------------------------------------------------------------------------------------------------------------------------------------------------------------------------------------------------------------------------------------------------------------------------------------------------------------------------------------------------------|----------------------------------------------------------------------------------------------------------------------------------------------------------------------------------------------------------------------------------------------------------------------------------------------------------------------------------------------------------------------------------------------------------------------------------------------------------------------------------------------------------------------------------------------------------------------------------------------------|-----------------------------------------------------------------------------------------------------------------------------------------------------------------------------------------------------------------------------------------------------------------------------------------------------------------------------------------------------------------------------------------------------------------------------------------------------------------------------|
| <p>Versions/ Versioni</p> | | | |
| <p>Yori Outline 24V - Zoom</p> |  <p>Yori Outline 24V - Zoom</p> |  <p>Yori Outline 24V - Zoom Curved</p> | |
| <p>Finishes/ Finiture</p> <p>Special finishes/ Finiture speciali</p> |  <p>12 Embossed matte white/ Bianco opaco gofrato</p>  <p>01 Chrome/ Cromo</p>  <p>D0 Brushed brass/ Ottone spazzolato</p>  <p>M0 Brushed aluminium/ Alluminio spazzolato</p> |  <p>31 Embossed matte black/ Nero opaco gofrato</p>  <p>B0 Royal matte black/ Nero opaco royal</p>  <p>E0 Brushed gold/ Oro spazzolato</p>  <p>N0 Brushed copper/ Rame spazzolato</p> |  <p>C0 Royal matte white/ Bianco opaco royal</p>  <p>L0 Antiqued brushed bronze/ Bronzo antico spazzolato</p>  <p>T1 Anodized Bronze/ Bronzo Anodizzato</p> |
| <p>Adjustability/ Orientabilità</p> |  <p>Horizontal axis/ Asse orizzontale</p> |  <p>Vertical axis/ Asse verticale</p> | |
| <p>IP</p> | <p>20</p> | | |
| <p>Control systems</p> | <p>On/Off, DALI</p> | | |
| <p>Insulation class</p> | <p>II</p> | | |
| <p>Certifications</p> | <p>CE UK CA</p> | | |

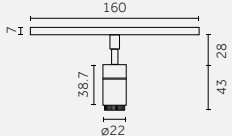
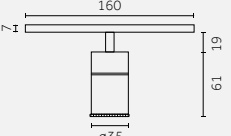
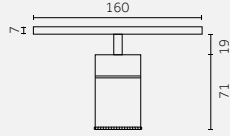
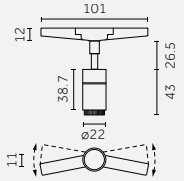
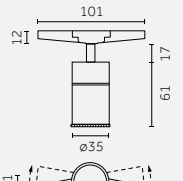
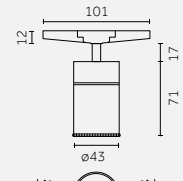

| | Ø 22 mm | Ø 35 mm | Ø 43 mm |
|-----------------------------------------------------------------------------------|--------------------------------------------------------------------------------------------------------|----------------------------------------------------------------------------------------------------------|-------------------------------------------------------------------------------------------------------------|
| Yori Outline 24V - Zoom |  <p>p.42</p> |  <p>p.43</p> |  <p>p.44</p> |
| Yori Outline 24V - Zoom Curved |  <p>p.42</p> |  <p>p.43</p> |  <p>p.44</p> |
|  | Zoom (7° - 14°) | Zoom (9° - 21°) | Zoom (13°-37°) |
| Light source/ Sorgente luminosa | POWER LED 2 W 140 lm - 145 lm L90 B10=50,000 h 2700 K; 3000 K SDCM <3 CRI >90 | POWER LED 2,5 W 195 lm - 200 lm L90 B10=50,000 h 2700 K; 3000 K SDCM <3 CRI >90 | POWER LED 4 W; 9 W 410 lm - 730 lm L90 B10=50,000 h 2700 K; 3000 K SDCM <3 CRI >90 |

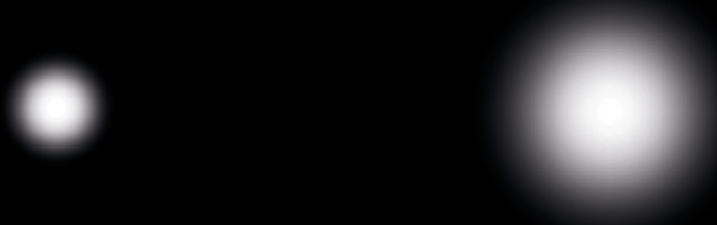

| | | | |
|-----|-----|-------|-----|
| Ø22 | 7° | ————— | 14° |
| Ø35 | 9° | ————— | 21° |
| Ø43 | 13° | ————— | 37° |

^{EN} The knurled ring on the projector allows to adjust the beam angle from 7° to 37° depending on fitting diameter.
^{IT} L'anello zigrinato sul proiettore permette l'orientamento del fascio da 7° a 37° in base al diametro.



^{EN} Yori Outline 24V - Zoom is available with the curved adapter too.

^{IT} Yori Outline 24V - Zoom è disponibile anche con adattatore curvo.

Ø 22mm | Precision

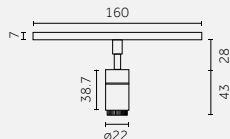
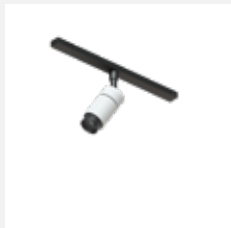

Code example:
0 - GS41 0 - HW 12

Track Outline 24V: p.91-108
 Finishes: p.56-57
 Photometric data:
www.reggiani.net

| 2 W | | POWERLED | | Lumen delivered up to 64 lm / Lumen maintenance: L90 B10=50,000h | | | | | | |
|-------------------|----------------------|-----------------|-----------|------------------------------------------------------------------|-----|-----|------|-----------|--|--|
| Driver | Version | Optics zoom | LED | K | CRI | lm | SDCM | Finishes | | |
| <u>0</u> On-Off | <u>GS41</u> Standard | <u>0</u> 7°-14° | <u>HW</u> | 2700 | >90 | 140 | <3 | <u>12</u> | | |
| <u>D</u> DALI | | | <u>HQ</u> | 3000 | >90 | 145 | <3 | <u>31</u> | | |
| LED nominal lumen | | | | | | | | <u>01</u> | | |
| | | | | | | | | <u>B0</u> | | |
| | | | | | | | | <u>C0</u> | | |
| | | | | | | | | <u>D0</u> | | |
| | | | | | | | | <u>E0</u> | | |
| | | | | | | | | <u>L0</u> | | |
| | | | | | | | | <u>M0</u> | | |
| | | | | | | | | <u>N0</u> | | |
| | | | | | | | | <u>T1</u> | | |

Ø 22mm | Precision Curved

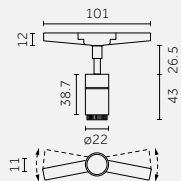
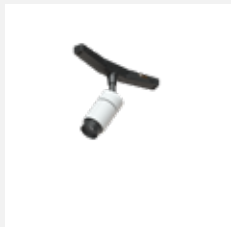

Code example:
0 - GS61 0 - HW 12

Track Outline 24V: p.91-108
 Finishes: p.56-57
 Photometric data:
www.reggiani.net

| 2 W | | POWERLED | | Lumen delivered up to 64 lm / Lumen maintenance: L90 B10=50,000h | | | | | | |
|-------------------|--------------------|-----------------|-----------|------------------------------------------------------------------|-----|-----|------|-----------|--|--|
| Driver | Version | Optics zoom | LED | K | CRI | lm | SDCM | Finishes | | |
| <u>0</u> On-Off | <u>GS61</u> Curved | <u>0</u> 7°-14° | <u>HW</u> | 2700 | >90 | 140 | <3 | <u>12</u> | | |
| | | | <u>HQ</u> | 3000 | >90 | 145 | <3 | <u>31</u> | | |
| LED nominal lumen | | | | | | | | <u>01</u> | | |
| | | | | | | | | <u>B0</u> | | |
| | | | | | | | | <u>C0</u> | | |
| | | | | | | | | <u>D0</u> | | |
| | | | | | | | | <u>E0</u> | | |
| | | | | | | | | <u>L0</u> | | |
| | | | | | | | | <u>M0</u> | | |
| | | | | | | | | <u>N0</u> | | |
| | | | | | | | | <u>T1</u> | | |

Ø 35mm | Precision

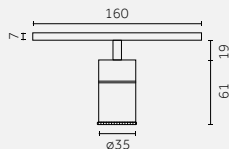
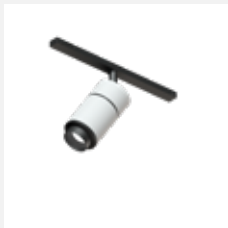

Code example:

0 . **NS41** 0 . **HW** **12**

Track Outline 24V: p.91-108

Finishes: p.56-57

Photometric data:

www.reggiani.net

2.5 W POWER LED Lumen delivered up to 117 lm / Lumen maintenance: L90 B10=50,000h

| Driver | Version | Optics zoom | LED | K | CRI | lm | SDCM | Finishes |
|----------|----------------------|-------------|-----------|------|-----|-----|------|-----------|
| 0 On-Off | NS41 Standard | 0 9°-21° | HW | 2700 | >90 | 195 | <3 | 12 |
| D DALI | | | HQ | 3000 | >90 | 200 | <3 | 31 |

LED nominal lumen

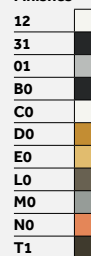

Ø 35mm | Precision Curved

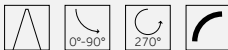
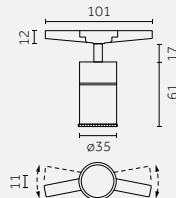
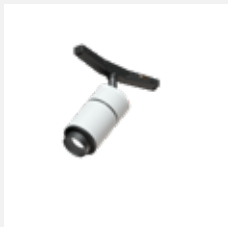

Code example:

0 . **NS61** 0 . **HW** **12**

Track Outline 24V: p.91-108

Finishes: p.56-57

Photometric data:

www.reggiani.net

2.5 W POWER LED Lumen delivered up to 117 lm / Lumen maintenance: L90 B10=50,000h

| Driver | Version | Optics zoom | LED | K | CRI | lm | SDCM | Finishes |
|----------|--------------------|-------------|-----------|------|-----|-----|------|-----------|
| 0 On-Off | NS61 Curved | 0 9°-21° | HW | 2700 | >90 | 195 | <3 | 12 |
| | | | HQ | 3000 | >90 | 200 | <3 | 31 |

LED nominal lumen

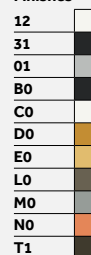

Ø 43mm | Precision

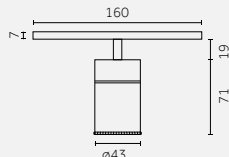
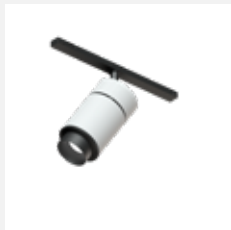

Code example:
0 . **PS41** **0** . **HW** **12**

Track Outline 24V: p.91-108
 Finishes: p.56-57
 Photometric data:
www.reggiani.net

| 4 W | | POWER LED | | Lumen delivered up to 205 lm / Lumen maintenance: L90 B10=50,000h | | | | | | |
|-------------------|----------------------|------------------|-----------|-------------------------------------------------------------------|-----|-----|------|-----------|--|--|
| Driver | Version | Optics zoom | LED | K | CRI | lm | SDCM | Finishes | | |
| 0 On-Off | PS41 Standard | 0 13°-37° | HW | 2700 | >90 | 410 | <3 | 12 | | |
| D DALI | | | HQ | 3000 | >90 | 415 | <3 | 31 | | |
| LED nominal lumen | | | | | | | | 01 | | |
| | | | | | | | | B0 | | |
| | | | | | | | | C0 | | |
| | | | | | | | | D0 | | |
| | | | | | | | | E0 | | |
| | | | | | | | | L0 | | |
| | | | | | | | | M0 | | |
| | | | | | | | | N0 | | |
| | | | | | | | | T1 | | |

| 9 W | | POWER LED | | Lumen delivered up to 456 lm / Lumen maintenance: L90 B10=50,000h | | | | | | |
|-------------------|----------------------|------------------|-----------|-------------------------------------------------------------------|-----|-----|------|-----------|--|--|
| Driver | Version | Optics | LED | K | CRI | lm | SDCM | Finishes | | |
| 0 On-Off | PS42 Standard | 0 13°-37° | HW | 2700 | >90 | 725 | <3 | 12 | | |
| D DALI | | | HQ | 3000 | >90 | 730 | <3 | 31 | | |
| LED nominal lumen | | | | | | | | B0 | | |
| | | | | | | | | C0 | | |
| | | | | | | | | D0 | | |
| | | | | | | | | E0 | | |
| | | | | | | | | L0 | | |
| | | | | | | | | M0 | | |
| | | | | | | | | N0 | | |
| | | | | | | | | T1 | | |

Ø 43mm | Precision Curved

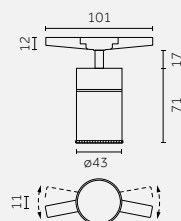
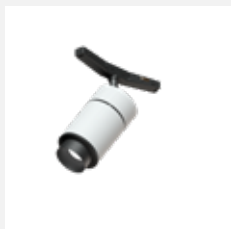

Code example:
0 . **PS61** **0** . **HW** **12**

Track Outline 24V: p.91-108
 Finishes: p.56-57
 Photometric data:
www.reggiani.net

| 4 W | | POWER LED | | Lumen delivered up to 205 lm / Lumen maintenance: L90 B10=50,000h | | | | | | |
|-------------------|--------------------|------------------|-----------|-------------------------------------------------------------------|-----|-----|------|-----------|--|--|
| Driver | Version | Optics zoom | LED | K | CRI | lm | SDCM | Finishes | | |
| 0 On-Off | PS61 Curved | 0 13°-37° | HW | 2700 | >90 | 410 | <3 | 12 | | |
| | | | HQ | 3000 | >90 | 415 | <3 | 31 | | |
| LED nominal lumen | | | | | | | | 01 | | |
| | | | | | | | | B0 | | |
| | | | | | | | | C0 | | |
| | | | | | | | | D0 | | |
| | | | | | | | | E0 | | |
| | | | | | | | | L0 | | |
| | | | | | | | | M0 | | |
| | | | | | | | | N0 | | |
| | | | | | | | | T1 | | |

















| 9 W | | POWER LED | | Lumen delivered up to 456 lm / Lumen maintenance: L90 B10=50,000h | | | | | | |
|-------------------|--------------------|------------------|-----------|-------------------------------------------------------------------|-----|-----|------|-----------|--|--|
| Driver | Version | Optics | LED | K | CRI | lm | SDCM | Finishes | | |
| 0 On-Off | PS62 Curved | 0 13°-37° | HW | 2700 | >90 | 725 | <3 | 12 | | |
| | | | HQ | 3000 | >90 | 730 | <3 | 31 | | |
| LED nominal lumen | | | | | | | | B0 | | |
| | | | | | | | | C0 | | |
| | | | | | | | | D0 | | |
| | | | | | | | | E0 | | |
| | | | | | | | | L0 | | |
| | | | | | | | | M0 | | |
| | | | | | | | | N0 | | |
| | | | | | | | | T1 | | |

Yori Pendant Outline 24V



EN Yori Pendant Outline 24V is the new suspension solution for 24V track characterized by sleek design and excellent lighting results. It is available in 3 diameters (Ø22mm, Ø35mm, Ø43mm) and 3 heights (H 150mm, H 220mm, H 400mm). The 11 color finishes make the product extremely applicable for every project.

IT Yori Pendant Outline 24V è la nuova soluzione di illuminazione a sospensione per binari a 24V caratterizzata da design pulito ed eccellenti risultati illuminotecnici. E' disponibile in 3 diametri (Ø22mm, Ø35mm, Ø43mm) e due altezze (H 150mm, H 220mm, H 400mm). Le 11 finiture disponibili e l'ampia gamma di accessori tecnici rendono il prodotto estremamente versatile per ogni progetto.

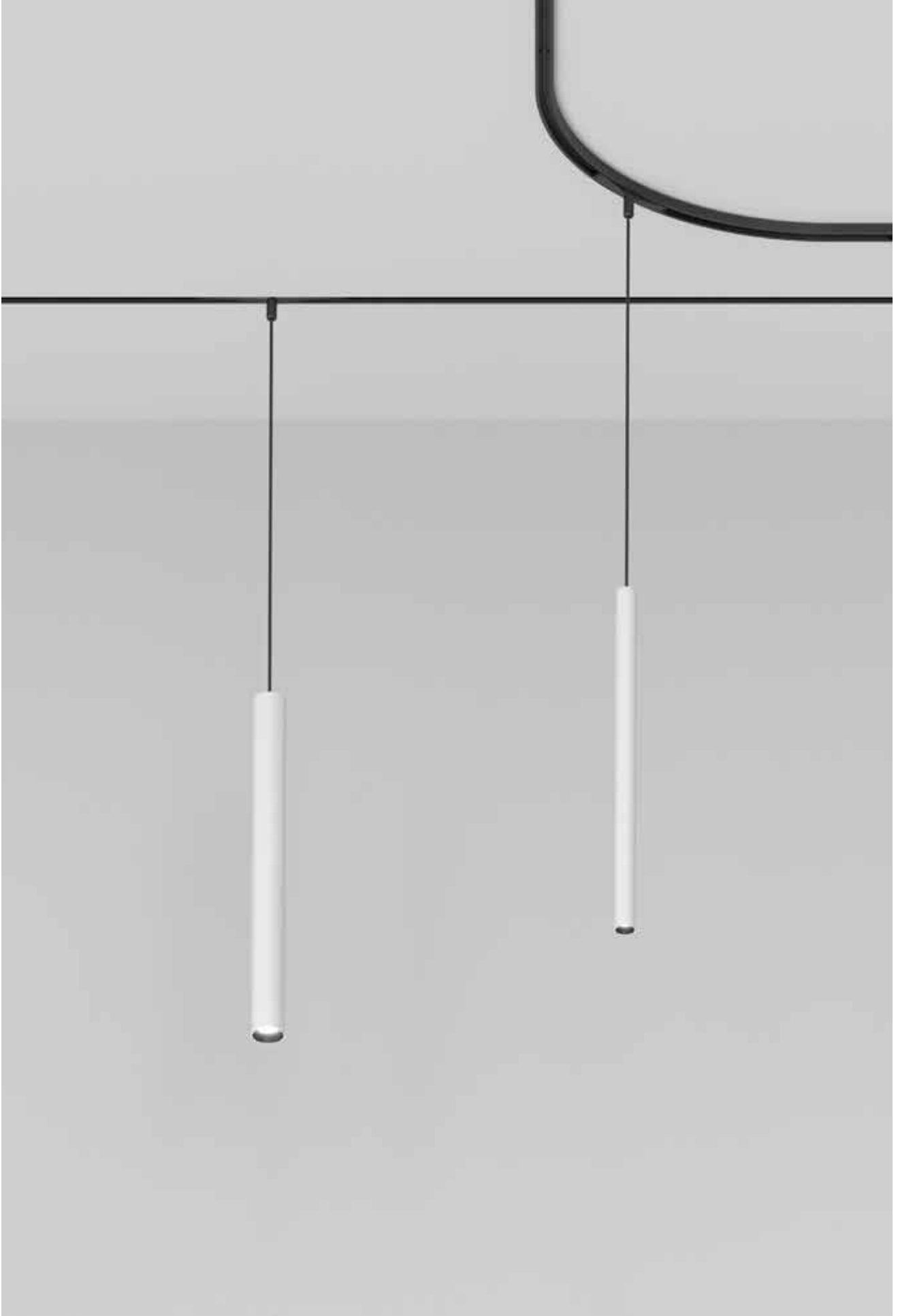

| | | | |
|----------------------------------------|-------------------------------------------------------------------------------------------------------------------------------------------------------------------------------------------------------------------------------------------------------------|----------------------------------------------------------------------------------------------------------------------------------------------------------------------------------|--------------------------------------------------------------------------------------------------------------------------------------------------------------------------------------------------|
| Versions/ Versioni | | | |
| Yori Pendant Outline 24V |  <p data-bbox="456 539 660 562">Yori Pendant Outline 24V</p> |  <p data-bbox="786 539 1062 562">Yori Pendant Outline 24V - Curved</p> | |
| Finishes/ Finiture |  <p data-bbox="456 813 647 875">12 Embossed matte white/ Bianco opaco goffrato</p> |  <p data-bbox="786 813 978 875">31 Embossed matte black/ Nero opaco goffrato</p> | |
| Special finishes/ Finiture speciali |  <p data-bbox="456 1111 528 1173">01 Chrome/ Cromo</p> |  <p data-bbox="786 1111 938 1173">B0 Royal matte black/ Nero opaco royal</p> |  <p data-bbox="1106 1111 1257 1173">C0 Royal matte white/ Bianco opaco royal</p> |
| |  <p data-bbox="456 1420 604 1482">D0 Brushed brass/ Ottone spazzolato</p> |  <p data-bbox="786 1420 911 1482">E0 Brushed gold/ Oro spazzolato</p> |  <p data-bbox="1106 1420 1318 1482">L0 Antiqued brushed bronze/ Bronzo antico spazzolato</p> |
| |  <p data-bbox="456 1729 620 1792">M0 Brushed aluminium/ Alluminio spazzolato</p> |  <p data-bbox="786 1729 927 1792">N0 Brushed copper/ Rame spazzolato</p> |  <p data-bbox="1106 1729 1262 1792">T1 Anodized Bronze/ Bronzo Anodizzato</p> |
| IP | 20 | | |
| Control systems | On/Off, DALI | | |
| Insulation class |  | | |
| Certifications |    | | |

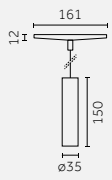
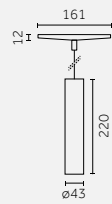
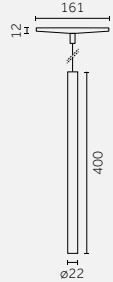
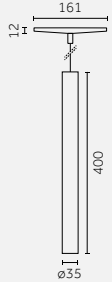

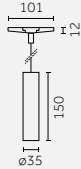
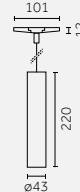
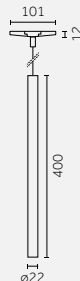
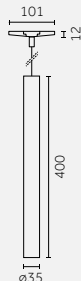
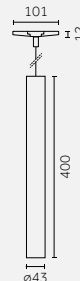
| | Ø 22 mm | Ø 35 mm | Ø 43 mm |
|------------------------------------|---------------------------------------------------------------------------------------------------------------------------------------------------------------------------------------------------|------------------------------------------------------------------------------------------------------------------------------------------------------------------------------------------------------------------------------------|--------------------------------------------------------------------------------------------------------------------------------------------------------------------------------------------------------------------------------------------------------------------------------------------------|
| Yori Pendant Outline 24V | |  <p>p.59</p> |  <p>p.61</p> |
| |  <p>p.58</p> |  <p>p.60</p> |  <p>p.62</p> |
| Yori Pendant Outline 24V Curved | |  <p>p.59</p> |  <p>p.61</p> |
| |  <p>p.58</p> |  <p>p.60</p> |  <p>p.62</p> |
| △ | Narrow (10°) Medium (28°) Wide (33°) | Narrow (11°) Medium (26°) Wide (33°) | Narrow (16°) Medium (23°) Wide (34°) |
| Light source/ Sorgente luminosa | <p>POWER LED 2 W 245 lm - 286 lm L90 B10=50,000 h 2700 K; 3000 K; 4000 K SDCM <3 CRI >90</p> <p>2000 K; 2200 K; 2500 K; 3500 K with accessories p.63</p> | <p>POWER LED 3,5 W 355 lm - 406 lm L90 B10=50,000 h 2700 K; 3000 K; 4000 K SDCM <3 CRI >90</p> <p>2000 K; 2200 K; 2500 K; 3500 K with accessories p.64</p> <p>7W available on request</p> | <p>POWER LED 5 W 550 lm - 640 lm L90 B10=50,000 h 2700 K; 3000 K; 4000 K SDCM <3 CRI >90</p> <p>2000 K; 2200 K; 2500 K; 3500 K with accessories p.65</p> <p>On request: QT (Tunable white) DT (Warm Dimming)</p> <p>9W available on request</p> |



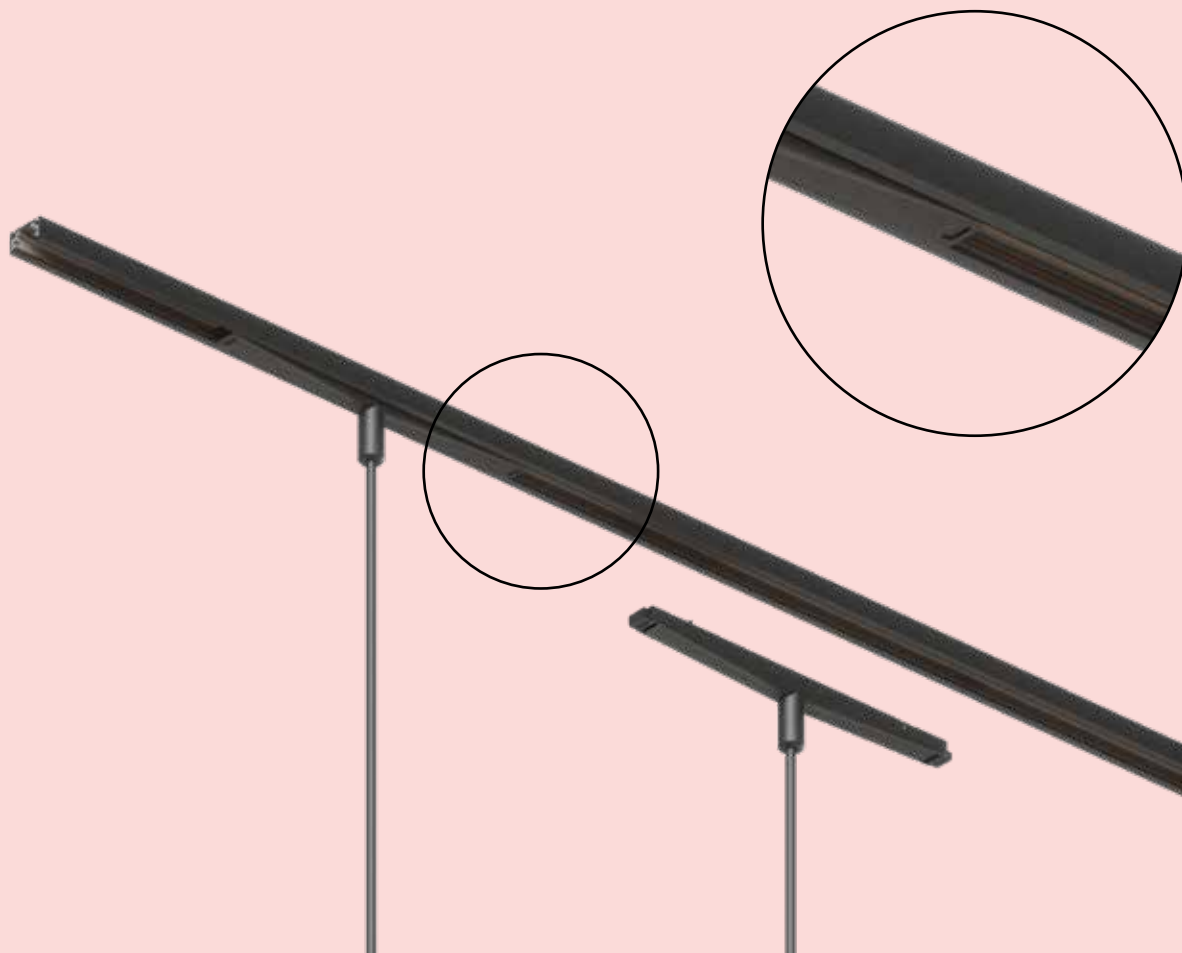

^{EN} The "lock-in" system of the adapter sustains the product weight in total security and assures stability on the track.

^{IT} Il sistema "lock-in" dell'adattatore sostiene il peso del prodotto in totale sicurezza e assicura stabilità sul binario.



^{EN} Linear adapter for linear track mounting.

^{IT} Adattatore lineare per montaggio su binari lineari.

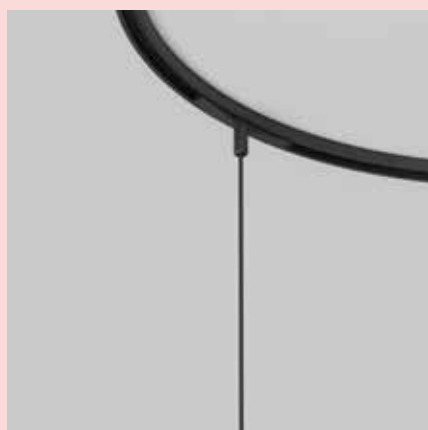

^{EN} Curved adapter for curved track mounting.

^{IT} Adattatore curvo per montaggio su binari curvi.

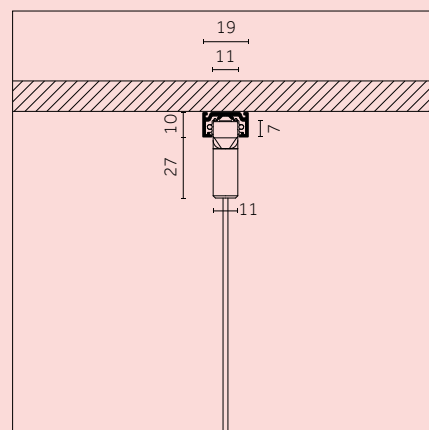

^{EN} Adapter for Outline track mounting.

^{IT} Adattatore per binari Outline.

EN Yori Pendant Outline 24V permits to personalize the light beam through the use of solid and hollow decorative cylinders that guarantee soft, diffused lighting to enable suggestive, elegant applications.

IT Yori Pendant Outline 24V permette la personalizzazione del fascio di luce attraverso cilindri decorativi pieni e vuoti, che permettono un effetto luminoso morbido e diffuso, realizzando suggestivi scenari luminosi.



EN The solid decorative cylinders, thanks to the frosted external surface, guarantee a diffused light and a soft and wide beam, with a minimum glare. Ideal for elegant and out-of-the-ordinary lighting effects.

IT I cilindri decorativi pieni, grazie all'acidatura presente sulla parte esterna, garantiscono una luce diffusa e un fascio morbido, con un abbaglio minimo. Ideale per effetti di luce eleganti e non banali.

EN The hollow cylinders, on the other hand, guarantee a more precise light. With the Warm Dimming technology, the cylinders' colors adjust to the different color temperatures, creating even more unique and striking lighting scenarios.

IT I cilindri vuoti garantiscono una luce più precisa. Con la tecnologia Warm Dimming, i cilindri si colorano grazie alle diverse temperature di colore, realizzando scenari luminosi ancora più unici e suggestivi.

| Diameter/ Diametro | Length/ Lunghezza | |
|-----------------------|----------------------------------------------|----------------------------------------------|
| | Hollow opal cylinder/ Cilindro opale cavo | Solid opal cylinder/ Cilindro opale pieno |
| Ø 22 mm | | |
| Ø 35 mm | | |
| Ø 43 mm | | |



EN Decorative cylinders can also be used with colored filters and selective filters (p.63-65).

IT I cilindri decorativi possono essere utilizzati anche con filtri colorati e filtri selettivi (p.63-65).

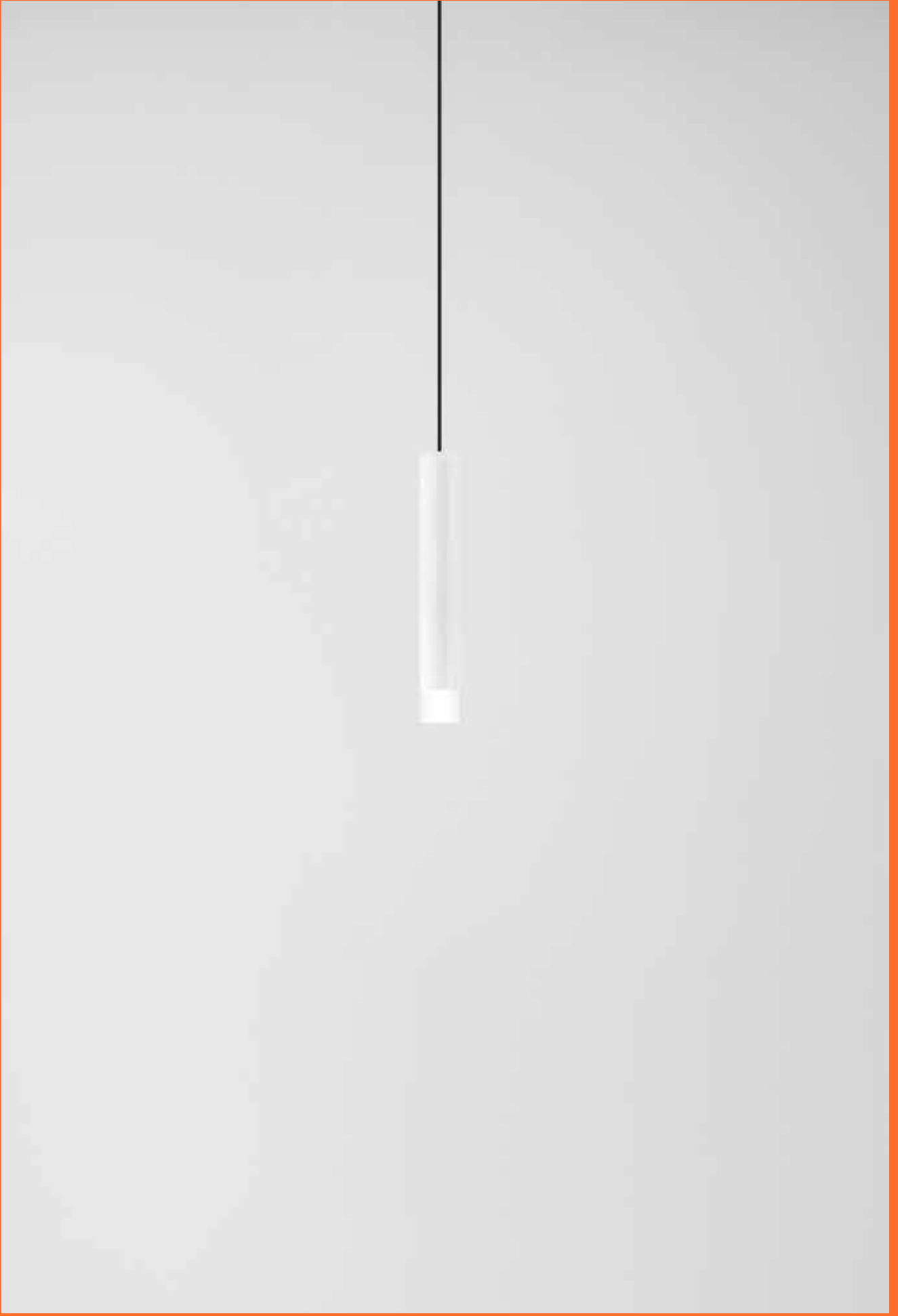

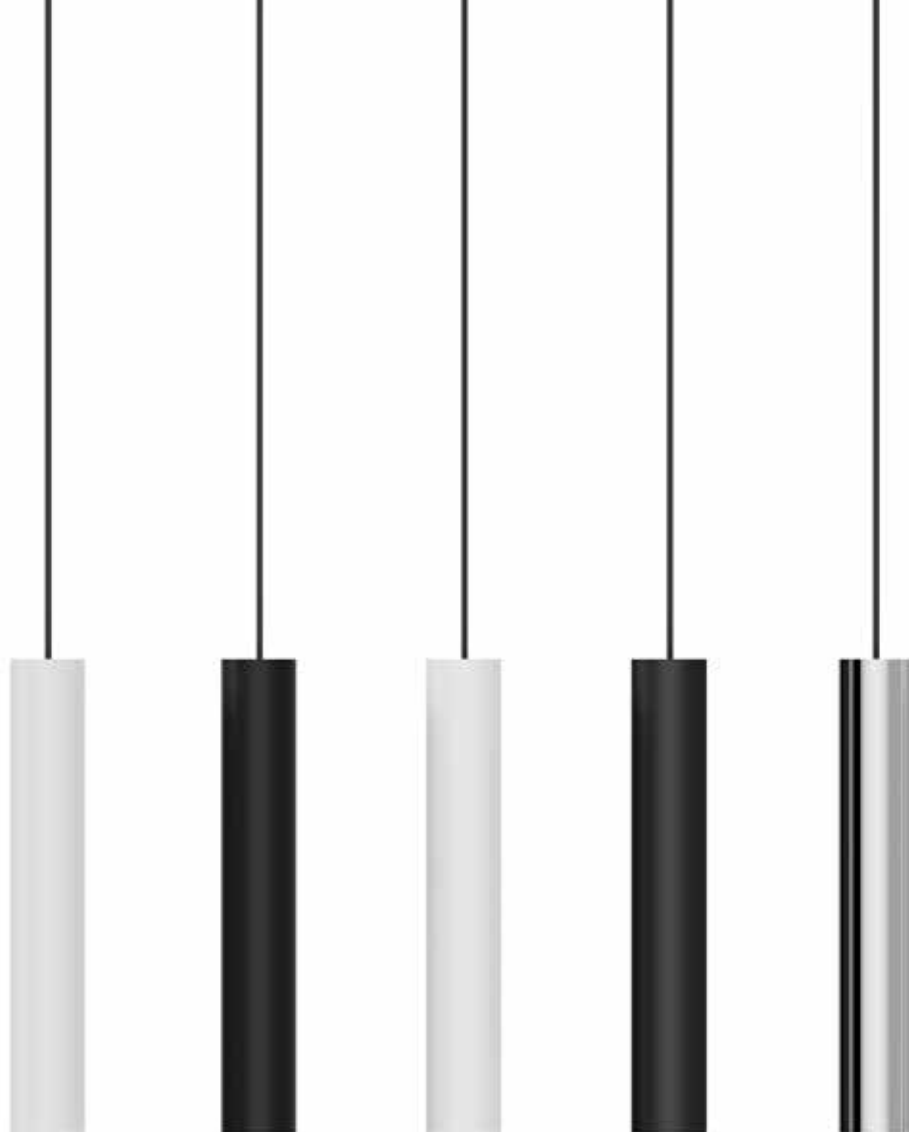

12

31

C0

B0

01

- 12** Embossed matte white/
Bianco opaco goffrato
- 31** Embossed matte black/
Nero opaco goffrato
- C0** Royal matte white/
Bianco opaco royal
- B0** Royal matte black/
Nero opaco royal
- 01** Chrome/
Cromo
- M0** Brushed aluminium/
Alluminio spazzolato

- E0** Brushed gold/
Oro spazzolato
- D0** Brushed brass/
Ottone spazzolato
- N0** Brushed copper/
Rame spazzolato
- L0** Antiqued brushed bronze/
Bronzo spazzolato anticato
- T1** Anodized bronze/
Bronzo anodizzato



M0

E0

D0

N0

L0

T1

Ø 22mm | H 400mm



Code example:

0 - RS40 B - HW 12

Accessories: p.63

Track Outline 24V: p.91-108

Finishes: p.56-57

Photometric data:

www.reggiani.net

Notes:

2000K; 2200K; 2500K; 3500K
with accessories p.63

2 W POWERLED

Lumen delivered up to 87 lm / Lumen maintenance: L90 B10=50,000h

| Driver | Version | Optics | LED | K | CRI | lm | SDCM | Finishes |
|-------------------|---------------|--------------|-----|------|-----|-----|------|----------|
| 0 On-Off | RS40 Standard | B 10° Narrow | HW | 2700 | >90 | 245 | <3 | 12 |
| D DALI | | E 28° Medium | HQ | 3000 | >90 | 265 | <3 | 31 |
| | | H 33° Wide | HN | 4000 | >90 | 286 | <3 | 01 |
| LED nominal lumen | | | | | | | | |
| | | | | | | | | B0 |
| | | | | | | | | C0 |
| | | | | | | | | D0 |
| | | | | | | | | E0 |
| | | | | | | | | L0 |
| | | | | | | | | M0 |
| | | | | | | | | N0 |
| | | | | | | | | T1 |

Ø 22mm | H 400mm Curved



Code example:

0 - RS60 B - HW 12

Accessories: p.63

Track Outline 24V: p.91-108

Finishes: p.56-57

Photometric data:

www.reggiani.net

Notes:

2000K; 2200K; 2500K; 3500K
with accessories p.63

2 W POWERLED

Lumen delivered up to 87 lm / Lumen maintenance: L90 B10=50,000h

| Driver | Version | Optics | LED | K | CRI | lm | SDCM | Finishes |
|-------------------|-------------|--------------|-----|------|-----|-----|------|----------|
| 0 On-Off | RS60 Curved | B 10° Narrow | HW | 2700 | >90 | 245 | <3 | 12 |
| | | E 28° Medium | HQ | 3000 | >90 | 265 | <3 | 31 |
| | | H 33° Wide | HN | 4000 | >90 | 286 | <3 | 01 |
| LED nominal lumen | | | | | | | | |
| | | | | | | | | B0 |
| | | | | | | | | C0 |
| | | | | | | | | D0 |
| | | | | | | | | E0 |
| | | | | | | | | L0 |
| | | | | | | | | M0 |
| | | | | | | | | N0 |
| | | | | | | | | T1 |

Ø 35mm | H 150mm

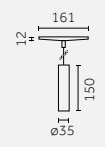

Code example:
0 . **TS41** **B** . **HW** **12**

Accessories: p.64
 Track Outline 24V: p.91-108
 Finishes: p.56-57
 Photometric data:
 www.reggiani.net

Notes:
 2000K; 2200K; 2500K; 3500K
 with accessories p.64

7W available on request /
 7W disponibili su richiesta

3.5 W POWER LED Lumen delivered up to 282 lm / Lumen maintenance: L90 B10=50,000h

| Driver | Version | Optics | LED | K | CRI | lm | SDCM | Finishes |
|-------------------|----------------------|---------------------|-----------|------|-----|-----|------|-----------|
| 0 On-Off | TS41 Standard | B 11° Narrow | HW | 2700 | >90 | 355 | <3 | 12 |
| D DALI | | E 26° Medium | HQ | 3000 | >90 | 375 | <3 | 31 |
| | | H 33° Wide | HN | 4000 | >90 | 405 | <3 | 01 |
| LED nominal lumen | | | | | | | | |
| | | | | | | | | B0 |
| | | | | | | | | C0 |
| | | | | | | | | D0 |
| | | | | | | | | E0 |
| | | | | | | | | L0 |
| | | | | | | | | M0 |
| | | | | | | | | N0 |
| | | | | | | | | T1 |

Ø 35mm | H 150mm Curved

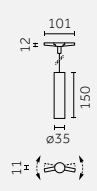

Code example:
0 . **TS61** **B** . **HW** **12**

Accessories: p.64
 Track Outline 24V: p.91-108
 Finishes: p.56-57
 Photometric data:
 www.reggiani.net

Notes:
 2000K; 2200K; 2500K; 3500K
 with accessories p.64

7W available on request /
 7W disponibili su richiesta

3.5 W POWER LED Lumen delivered up to 282 lm / Lumen maintenance: L90 B10=50,000h

| Driver | Version | Optics | LED | K | CRI | lm | SDCM | Finishes |
|-------------------|--------------------|---------------------|-----------|------|-----|-----|------|-----------|
| 0 On-Off | TS61 Curved | B 11° Narrow | HW | 2700 | >90 | 355 | <3 | 12 |
| | | E 26° Medium | HQ | 3000 | >90 | 375 | <3 | 31 |
| | | H 33° Wide | HN | 4000 | >90 | 405 | <3 | 01 |
| LED nominal lumen | | | | | | | | |
| | | | | | | | | B0 |
| | | | | | | | | C0 |
| | | | | | | | | D0 |
| | | | | | | | | E0 |
| | | | | | | | | L0 |
| | | | | | | | | M0 |
| | | | | | | | | N0 |
| | | | | | | | | T1 |

Ø 35mm | H 400mm



Code example:

0 - TS42 B - HW 12

Accessories: p.65

Track Outline 24V: p.91-108

Finishes: p.56-57

Photometric data:

www.reggiani.net

Notes:

2000K; 2200K; 2500K; 3500K
with accessories p.64

7W available on request/
7W disponibili su richiesta

3.5 W POWERLED

Lumen delivered up to 282 lm / Lumen maintenance: L90 B10=50,000h

| Driver | Version | Optics | LED | K | CRI | lm | SDCM | Finishes |
|-------------------|---------------|--------------|-----|------|-----|-----|------|----------|
| 0 On-Off | TS42 Standard | B 11° Narrow | HW | 2700 | >90 | 355 | <3 | 12 |
| D DALI | | E 26° Medium | HQ | 3000 | >90 | 375 | <3 | 31 |
| | | H 33° Wide | HN | 4000 | >90 | 405 | <3 | 01 |
| LED nominal lumen | | | | | | | | |
| | | | | | | | | B0 |
| | | | | | | | | C0 |
| | | | | | | | | D0 |
| | | | | | | | | E0 |
| | | | | | | | | L0 |
| | | | | | | | | M0 |
| | | | | | | | | N0 |
| | | | | | | | | T1 |

Ø 35mm | H 400mm Curved



Code example:

0 - TS62 B - HW 12

Accessories: p.65

Track Outline 24V: p.91-108

Finishes: p.56-57

Photometric data:

www.reggiani.net

Notes:

2000K; 2200K; 2500K; 3500K
with accessories p.64

7W available on request/
7W disponibili su richiesta

3.5 W POWERLED

Lumen delivered up to 282 lm / Lumen maintenance: L90 B10=50,000h

| Driver | Version | Optics | LED | K | CRI | lm | SDCM | Finishes |
|-------------------|-------------|--------------|-----|------|-----|-----|------|----------|
| 0 On-Off | TS62 Curved | B 11° Narrow | HW | 2700 | >90 | 355 | <3 | 12 |
| | | E 26° Medium | HQ | 3000 | >90 | 375 | <3 | 31 |
| | | H 33° Wide | HN | 4000 | >90 | 405 | <3 | 01 |
| LED nominal lumen | | | | | | | | |
| | | | | | | | | B0 |
| | | | | | | | | C0 |
| | | | | | | | | D0 |
| | | | | | | | | E0 |
| | | | | | | | | L0 |
| | | | | | | | | M0 |
| | | | | | | | | N0 |
| | | | | | | | | T1 |

Ø 43mm | H 220mm

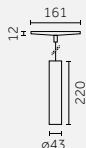

Code example:

0 . **VS41** B . **HW** **12**

Accessories: p.65

Track Outline 24V: p.91-108

Finishes: p.56-57

Photometric data:

www.reggiani.net

Notes:

2000K; 2200K; 2500K; 3500K
with accessories p.65

9W available on request/
9W disponibili su richiesta

| 5 W POWER LED | | Lumen delivered up to 535 lm / Lumen maintenance: L90 B10=50,000h | | | | | | | Finishes | |
|-------------------------------|----------------------|-------------------------------------------------------------------|-----------|------|-----|-----|------|-----------|----------|--|
| Driver | Version | Optics | LED | K | CRI | lm | SDCM | | | |
| 0 On-Off | VS41 Standard | B 16° Narrow | HW | 2700 | >90 | 550 | <3 | 12 | | |
| D DALI | | E 23° Medium | HQ | 3000 | >90 | 595 | <3 | 31 | | |
| | | H 34° Wide | HN | 4000 | >90 | 640 | <3 | 01 | | |
| LED nominal lumen | | | | | | | | B0 | | |
| QT (Tunable white) on request | | | | | | | | C0 | | |
| DT (Warm Dimming) on request | | | | | | | | D0 | | |
| | | | | | | | | E0 | | |
| | | | | | | | | L0 | | |
| | | | | | | | | M0 | | |
| | | | | | | | | N0 | | |
| | | | | | | | | T1 | | |

Ø 43mm | H 220mm Curved

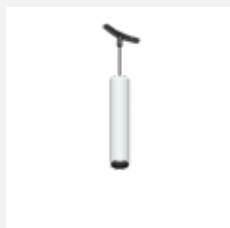

Code example:

0 . **VS61** B . **HW** **12**

Accessories: p.65

Track Outline 24V: p.91-108

Finishes: p.56-57

Photometric data:

www.reggiani.net

Notes:

2000K; 2200K; 2500K; 3500K
with accessories p.65

9W available on request/
9W disponibili su richiesta

| 5 W POWER LED | | Lumen delivered up to 535 lm / Lumen maintenance: L90 B10=50,000h | | | | | | | Finishes | |
|-------------------|--------------------|-------------------------------------------------------------------|-----------|------|-----|-----|------|-----------|----------|--|
| Driver | Version | Optics | LED | K | CRI | lm | SDCM | | | |
| 0 On-Off | VS61 Curved | B 16° Narrow | HW | 2700 | >90 | 550 | <3 | 12 | | |
| | | E 23° Medium | HQ | 3000 | >90 | 595 | <3 | 31 | | |
| | | H 34° Wide | HN | 4000 | >90 | 640 | <3 | 01 | | |
| LED nominal lumen | | | | | | | | B0 | | |
| | | | | | | | | C0 | | |
| | | | | | | | | D0 | | |
| | | | | | | | | E0 | | |
| | | | | | | | | L0 | | |
| | | | | | | | | M0 | | |
| | | | | | | | | N0 | | |
| | | | | | | | | T1 | | |

Ø 43mm | H 400mm



Code example:

0 - VS42 B - HW 12

Accessories: p.65

Track Outline 24V: p.91-108

Finishes: p.56-57

Photometric data:

www.reggiani.net

Notes:

2000K; 2200K; 2500K; 3500K
with accessories p.65

9W available on request/
9W disponibili su richiesta

| 5W POWERLED | | Lumen delivered up to 535 lm / Lumen maintenance: L90 B10=50,000h | | | | | | | Finishes | |
|-------------------------------|---------------|-------------------------------------------------------------------|-----|------|-----|-----|------|----|----------|--|
| Driver | Version | Optics | LED | K | CRI | lm | SDCM | | | |
| 0 On-Off | VS42 Standard | B 16° Narrow | HW | 2700 | >90 | 550 | <3 | 12 | | |
| D DALI | | E 23° Medium | HQ | 3000 | >90 | 595 | <3 | 31 | | |
| | | H 34° Wide | HN | 4000 | >90 | 640 | <3 | 01 | | |
| LED nominal lumen | | | | | | | | B0 | | |
| QT (Tunable white) on request | | | | | | | | C0 | | |
| DT (Warm Dimming) on request | | | | | | | | D0 | | |
| | | | | | | | | E0 | | |
| | | | | | | | | L0 | | |
| | | | | | | | | M0 | | |
| | | | | | | | | N0 | | |
| | | | | | | | | T1 | | |

Ø 43mm | H 400mm Curved



Code example:

0 - VS62 B - HW 12

Accessories: p.65

Track Outline 24V: p.91-108

Finishes: p.56-57

Photometric data:

www.reggiani.net

Notes:

2000K; 2200K; 2500K; 3500K
with accessories p.65

9W available on request/
9W disponibili su richiesta

| 5W POWERLED | | Lumen delivered up to 535 lm / Lumen maintenance: L90 B10=50,000h | | | | | | | Finishes | |
|-------------------|-------------|-------------------------------------------------------------------|-----|------|-----|-----|------|----|----------|--|
| Driver | Version | Optics | LED | K | CRI | lm | SDCM | | | |
| 0 On-Off | VS62 Curved | B 16° Narrow | HW | 2700 | >90 | 550 | <3 | 12 | | |
| | | E 23° Medium | HQ | 3000 | >90 | 595 | <3 | 31 | | |
| | | H 34° Wide | HN | 4000 | >90 | 640 | <3 | 01 | | |
| LED nominal lumen | | | | | | | | B0 | | |
| | | | | | | | | C0 | | |
| | | | | | | | | D0 | | |
| | | | | | | | | E0 | | |
| | | | | | | | | L0 | | |
| | | | | | | | | M0 | | |
| | | | | | | | | N0 | | |
| | | | | | | | | T1 | | |

Accessories

Yori Pendant Outline 24V | Ø 22mm

Optics accessories/ Accessori ottiche











| | | | | | | | |
|--|-------------------------------------------------------------------------------------------------------------|----------------------------------|---------------------------------------------------------------------------------------|--|--------------------------------------------------------------------------------------------------------------------------|----------------------------------|-----------------------|
| | Description Colored glass filter 1 mm/ Filtro in vetro colorato 1 mm Holder included | Code 0.26700.00 | Finishes 4A Red 5A Green 6A Blue 7A Pink 8A Yellow 9A Orange | | Description Selective filter 3000K - 3500K / Filtro selettivo 3000K - 3500K Holder included | Code 0.26705.00 | |
| | Description Selective filter 3000K - 2700K / Filtro selettivo 3000K - 2700K Holder included | Code 0.26701.00 | | | Description Selective filter 3000K - 4000K / Filtro selettivo 3000K - 4000K Holder included | Code 0.26706.00 | |
| | Description Selective filter 2700K - 2500K / Filtro selettivo 2700K - 2500K Holder included | Code 0.26702.00 | | | Description Elliptical beam lens / Lente per fascio ellittico Holder included | Code 0.26707.00 | |
| | Description Selective filter 2700K - 2200K / Filtro selettivo 2700K - 2200K Holder included | Code 0.26703.00 | | | Description Opal lens / Lente opale Holder included | Code 0.26708.00 | |
| | Description Selective filter 2700K - 2000K / Filtro selettivo 2700K - 2000K Holder included | Code 0.26704.00 | | | Description Spread lens / Lente diffondente Holder included | Code 0.26709.00 | |
| | | | | | Description Concentric circles / Cerchi concentrici Only for light beam B / Solo per fascio di luce B | Code 0.26582.00 | Finishes 31 |

Decorative accessories/ Accessori decorativi



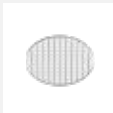

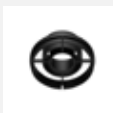

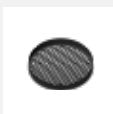
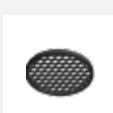
| | | | | | | | |
|--|--|------------------------------------------------------------------------------------------------------------------------|------------------------------------|--|--|------------------------------------------------------------------------------------------------------------------------|------------------------------------|
| | | Description Cylinder, solid version (Ø 22 mm, h 22 mm) / Cilindro versione piena (Ø 22 mm, h 22 mm) | Code 0.26040.0000 | | | Description Cylinder, solid version (Ø 22 mm, h 80 mm) / Cilindro versione piena (Ø 22 mm, h 80 mm) | Code 0.26041.0000 |
|--|--|------------------------------------------------------------------------------------------------------------------------|------------------------------------|--|--|------------------------------------------------------------------------------------------------------------------------|------------------------------------|

Yori Pendant Outline 24V | Ø 35 mm

Optics accessories/ Accessori ottiche

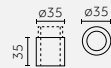
| Description | | Code | Finishes 4A Red 5A Green 6A Blue 7A Pink 8A Yellow 9A Orange | Description | | Code |
|-------------------------------------------------------------------------------------|--------------------------------------------------------------------------------------|-------------------|---------------------------------------------------------------------------------------------------------------------------------|----------------------------------------------------------------------------------------|------------------------------------------------------------------------------------------------------------|-------------------|
|  | Colored glass filter 1 mm/ Filtro in vetro colorato 1 mm Holder included | 0.26710.00 | |  | Selective filter 3000K - 4000K/ Filtro selettivo 3000K - 4000K Holder included | 0.26716.00 |
|  | Selective filter 3000K - 2700K/ Filtro selettivo 3000K - 2700K Holder included | 0.26711.00 | |  | Elliptical beam lens/ Lente per fascio ellittico Holder included | 0.26717.00 |
|  | Selective filter 2700K - 2500K/ Filtro selettivo 2700K - 2500K Holder included | 0.26712.00 | |  | Opal lens/ Lente opale Holder included | 0.26718.00 |
|  | Selective filter 2700K - 2200K/ Filtro selettivo 2700K - 2200K Holder included | 0.26713.00 | |  | Spread lens/ Lente diffondente Holder included | 0.26719.00 |
|  | Selective filter 2700K - 2000K/ Filtro selettivo 2700K - 2000K Holder included | 0.26714.00 | |  | Concentric circles/ Cerchi concentrici Only for light beam A and B/ Solo per fascio di luce A e B | 0.26583.00 |
|  | Selective filter 3000K - 3500K/ Filtro selettivo 3000K - 3500K Holder included | 0.26715.00 |  | Dense texture honeycomb louvre/ Griglia alveolare a maglia fitta Holder included | 0.26398.0000 | |
| | | |  | Wide texture honeycomb louvre/ Griglia alveolare a maglia larga Holder included | 0.26399.0000 | |

Decorative accessories/ Accessori decorativi

| | | | | | | | |
|-------------------------------------------------------------------------------------|-------------------------------------------------------------------------------------|-----------------------------------------------------------------------------------------------------------------------|------------------------------------|-------------------------------------------------------------------------------------|--------------------------------------------------------------------------------------|-----------------------------------------------------------------------------------------------------------------------|------------------------------------|
|  |  | Description Cylinder, solid version (Ø 35 mm, h 35 mm)/ Cilindro versione piena (Ø 35 mm, h 35 mm) | Code 0.26042.0000 |  |  | Description Cylinder, hollow version (Ø 35 mm, h 35 mm)/ Cilindro versione cava (Ø 35 mm, h 35 mm) | Code 0.26044.0000 |
|  |  | Description Cylinder, solid version (Ø 35 mm, h 70 mm)/ Cilindro versione piena (Ø 35 mm, h 70 mm) | Code 0.26043.0000 |  |  | Description Cylinder, hollow version (Ø 35 mm, h 70 mm)/ Cilindro versione cava (Ø 35 mm, h 70 mm) | Code 0.26045.0000 |

Yori Pendant Outline 24V | Ø 43 mm

Optics accessories/ Accessori ottiche

| Image | Description | Code | Finishes | Image | Description | Code | Finishes |
|-------|-----------------------------------------------------------------------------------------|---------------------|--------------------------------------------------------------------------------------------------------------|-------|------------------------------------------------------------------------------------------------------------|---------------------|------------------------------------------------------------------------|
| | Colored glass filter 1 mm/ Filtro in vetro colorato 1 mm Holder included | 0.26400.00 | 4A Red 5A Green 6A Blue 7A Pink 8A Yellow 9A Orange | | Wide texture honeycomb louvre/ Griglia alveolare a maglia larga Holder included | 0.26448.0000 | |
| | Colored gel slides (2 pieces)/ Vetrini per gel colorato (2 pezzi) Holder included | 0.26408.0000 | | | Elliptical beam lens / Lente per fascio ellittico Holder included | 0.26456.0000 | |
| | Selective filter 3000K - 2700K / Filtro selettivo 3000K - 2700K Holder included | 0.26557.0000 | | | Opal lens/ Lente opale Holder included | 0.26460.0000 | |
| | Selective filter 2700K - 2500K / Filtro selettivo 2700K - 2500K Holder included | 0.26416.0000 | | | Spread lens/ Lente diffondente Holder included | 0.26468.0000 | |
| | Selective filter 2700K - 2200K / Filtro selettivo 2700K - 2200K Holder included | 0.26424.0000 | | | Cross blade louvre/ Griglia a croce | 0.26476.0000 | |
| | Selective filter 2700K - 2000K / Filtro selettivo 2700K - 2000K Holder included | 0.26432.0000 | | | Barn doors/ Alette rompiflusso | 0.26484.0000 | |
| | Selective filter 3000K - 3500K / Filtro selettivo 3000K - 3500K Holder included | 0.26565.0000 | | | Cone 45° wall washer/ Cono 45° wall washer | 0.26488.00 | Finishes 12 <input type="checkbox"/> 31 <input type="checkbox"/> |
| | Selective filter 3000K - 4000K / Filtro selettivo 3000K - 4000K Holder included | 0.26573.0000 | | | Short snoot/ Cilindro corto | 0.26556.00 | Finishes 12 <input type="checkbox"/> 31 <input type="checkbox"/> |
| | Dense texture honeycomb louvre/ Griglia alveolare a maglia fitta Holder included | 0.26440.0000 | | | Concentric circles/ Cerchi concentrici Only for light beam A and B/ Solo per fascio di luce A e B | 0.26584.00 | Finishes 31 <input type="checkbox"/> |

Decorative accessories/ Accessori decorativi





| | | | | | | | |
|--|--------------------------|-----------------------------------------------------------------------------------------------------------------------|------------------------------------|--|--------------------------|-----------------------------------------------------------------------------------------------------------------------|------------------------------------|
| | <p>Ø43 Ø43 43</p> | Description Cylinder, solid version (Ø 43 mm, h 43 mm)/ Cilindro versione piena (Ø 43 mm, h 43 mm) | Code 0.26162.0000 | | <p>Ø43 Ø43 43</p> | Description Cylinder, hollow version (Ø 43 mm, h 43 mm)/ Cilindro versione cava (Ø 43 mm, h 43 mm) | Code 0.26164.0000 |
| | <p>Ø43 Ø43 86</p> | Description Cylinder, solid version (Ø 43 mm, h 86 mm)/ Cilindro versione piena (Ø 43 mm, h 86 mm) | Code 0.26163.0000 | | <p>Ø43 Ø43 86</p> | Description Cylinder, hollow version (Ø 43 mm, h 86 mm)/ Cilindro versione cava (Ø 43 mm, h 86 mm) | Code 0.26165.0000 |

Incline Outline 24V - Adjustable

^{EN} A linear, adjustable lighting solution completely integrated within the 24V track, characterized by miniaturized dimensions and adjustable body. Incline Outline 24V – Adjustable represents a sound retail lighting solution, especially in shop windows and other architectural structures. The 90° adjustability makes it possible to direct the light where it is needed. The custom-made optics ensure excellent performances with minimal glare.

^{IT} Soluzione d'illuminazione lineare orientabile integrata nei binari a 24V, caratterizzata da dimensioni ultra miniaturizzate e corpo orientabile. Incline Outline 24V - Adjustable rappresenta una soluzione di illuminazione perfetta per vetrine ed altre strutture architettoniche. L'orientabilità di 90° permette di direzionare il fascio di luce dove necessario. Le ottiche sviluppate appositamente garantiscono inoltre l'assenza di abbaglio.



| | |
|--------------------------------------------------|----------------------------------------------------------------------------------------------------------------------------------------------------------------------------------------------------------------------------------------------------------------------------------------------------------------------------------------------------------------------------|
| <p>Versions/ Versioni</p> | |
| <p>Incline Outline 24V Adjustable</p> | <div style="display: flex; justify-content: space-around; align-items: center;"> <div style="text-align: center;">  <p>62,5 mm</p> </div> <div style="text-align: center;">  <p>125 mm</p> </div> </div> |
| <p>Finishes/ Finiture</p> | <div style="text-align: center;">  </div> <p>31 Embossed matte black/ Nero opaco goffrato</p> |
| <p>Adjustability/ Orientabilità</p> | <div style="text-align: center;">  </div> <p>Horizontal axis/ Asse orizzontale</p> |
| <p>IP</p> | <p>20</p> |
| <p>Control systems</p> | <p>On/Off, DALI</p> |
| <p>Insulation class</p> | <p>□</p> |
| <p>Certifications</p> | <p>CE UK ENEC</p> |



| | 62,5 mm | 125 mm |
|--------------------------------------------|---------------------------------------------------------------------------------------------------------------------------------------------------------------------------------|---------------------------------------------------------------------------------------------------------------------------------------------------------------------------------|
| Incline Outline 24V Adjustable | | |
| | p.78 | p.78 |
| △ | Narrow (18°) Medium (24°) Medium-wide (35°) Wide (50°) | Narrow (18°) Medium (24°) Medium-wide (35°) Wide (50°) |
| Light source/ Sorgente luminosa | HIGH POWER LED 3 W 408 lm - 439 lm L90 B10=50,000h 2700 K; 3000 K; 4000 K SDCM <3 CRI >90 2000 K; 2200 K; 2500K; 3500K with accessories p.79 | HIGH POWER LED 6 W 752 lm - 878 lm L90 B10=50,000h 2700 K; 3000 K; 4000 K SDCM <3 CRI >90 2000 K; 2200 K; 2500K; 3500K with accessories p.80 |



EN Thanks to the miniaturized dimensions characterizing the 24V track and Incline Outline 24V - Adjustable, the system can be easily hidden between beam clamps and wooden slatts. The +/- 45° adjustability of Incline Outline 24V - Adjustable allows orientation of the beam, assuring an exceptional lighting result.

IT Grazie alle dimensioni miniaturizzate del binario 24V e di Incline Outline 24V - Adjustable, il sistema può essere facilmente integrato in strutture architettoniche come tra travi e doghe di legno. La possibilità di orientare Incline Outline 24V - Adjustable di +/- 45° permette di indirizzare il fascio garantendo l'eccellente risultato illuminotecnico.

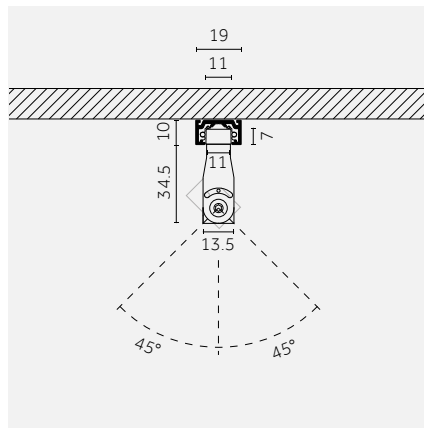
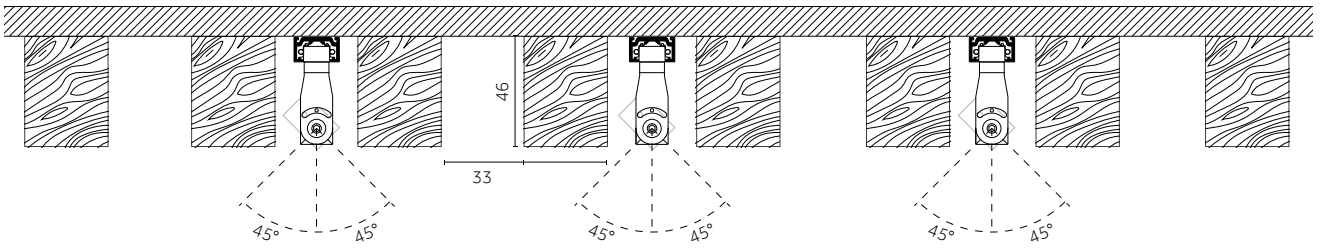

EN Complete integration with the structure.
 IT Integrazione completa con ogni struttura.

EN +/- 45° adjustability.
 IT Orientabilità di +/- 45°.



EN Incline Outline 24V - Adjustable represents an excellent solution for retail spaces, shop windows and other architectural structures. Thanks to its miniaturized dimensions, it can be easily integrated within shop window frames. Additionally, the 90° adjustability allows precise adjustment of the beam towards the product or object to be highlighted.

IT Incline Outline 24V - Adjustable rappresenta la soluzione migliore per gli spazi retail, soprattutto per le vetrine e per le altre strutture architettoniche. Grazie alla dimensione ultra-miniaturizzata, può essere facilmente integrato all'interno dei telai di struttura delle vetrine. In aggiunta, la possibilità di orientare il prodotto di 90° permette un corretto aggiustamento del fascio di luce verso ciò che deve essere illuminato.

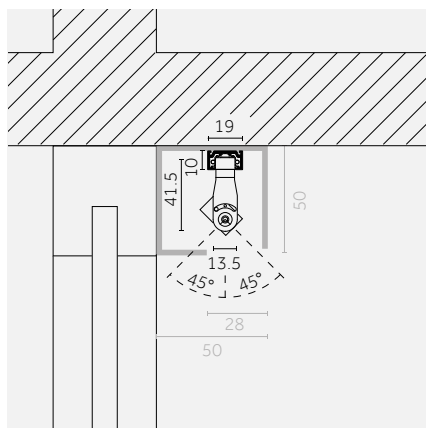
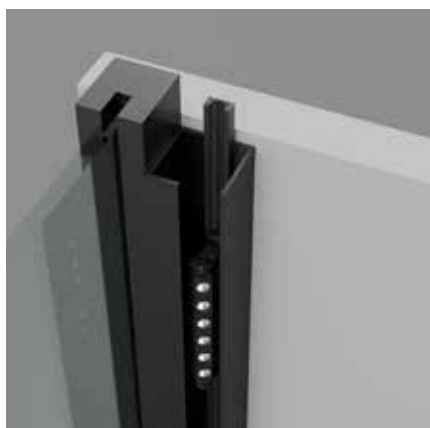

EN Complete integration with the structure.

IT Integrazione completa con la struttura.

EN +/- 45° adjustability.

IT Orientabilità di +/- 45°.



Customise your light



EN Incline Outline 24V - Adjustable can be personalised with a wide variety of technical and decorative accessories for unique flexibility (selective filters, honeycomb, spread lens accessory).

IT Incline Outline 24V - Adjustable può essere personalizzato grazie all'utilizzo di un'ampia varietà di accessori tecnici e decorativi, per una flessibilità di progettazione unica (filtri selettivi, griglia alveolare, lente prismatica).



Coloured filters/
Filtri colorati



Selective filters/
Filtri selettivi



Spread lens/
Lente prismatica



Honeycomb louvre/
Griglia alveolare



Opal lens/
Lente opale



Elliptical lens/
Lente ellittica



Snoot/
Cilindro anti-abbaglio



Snoot with opal filter/
Cilindro anti-abbaglio con
filtro opale



Decorative accessory/
Accessorio decorativo

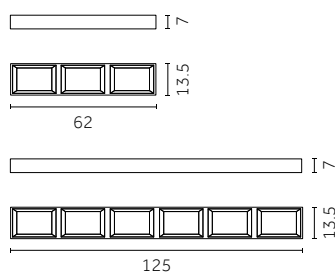

EN Accessories available in two different lengths.

IT Accessori disponibili in due diverse lunghezze.

62,5 mm

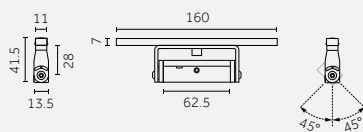

Code example:
0 - **BS01** **B** - **HW** **31**

Accessories: p.79
 Track Outline 24V: p.91-108
 Photometric data:
 www.reggiani.net

62,5 mm (3LED)

3 W HIGH POWER LED - 49 W/m

Lumen delivered up to 394 lm / Lumen maintenance: L90 B10=50,000h

| Driver | Version | Length | Diffuser | Optics | LED | K | CRI | lm | SDCM | Finishes |
|-----------------|-------------|---------|------------------|--------------------------|-----------|-------------------|-----|-----|------|-----------------------------------------------------------------------------------------|
| 0 On-Off | BS01 | 62,5 mm | Dark Performance | B 18° Narrow | HW | 2700 | >90 | 376 | <3 | 31 |
| D DALI | | | | E 24° Medium | HQ | 3000 | >90 | 408 | <3 | |
| | | | | H 35° Medium-wide | HN | 4000 | >90 | 439 | <3 | |
| | | | | M 50° Wide | | LED nominal lumen | | | | |

125 mm

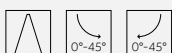
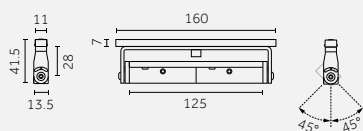
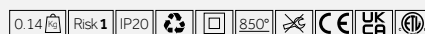

Code example:
0 - **CS02** **B** - **HW** **31**

Accessories: p.80
 Track Outline 24V: p.91-108
 Photometric data:
 www.reggiani.net

125 mm (6LED)

6 W HIGH POWER LED - 49 W/m

Lumen delivered up to 788 lm / Lumen maintenance: L90 B10=50,000h

| Driver | Version | Length | Diffuser | Optics | LED | K | CRI | lm | SDCM | Finishes |
|-----------------|-------------|--------|------------------|--------------------------|-----------|-------------------|-----|-----|------|-----------------------------------------------------------------------------------------|
| 0 On-Off | CS02 | 125 mm | Dark Performance | B 18° Narrow | HW | 2700 | >90 | 752 | <3 | 31 |
| D DALI | | | | E 24° Medium | HQ | 3000 | >90 | 815 | <3 | |
| | | | | H 35° Medium-wide | HN | 4000 | >90 | 878 | <3 | |
| | | | | M 50° Wide | | LED nominal lumen | | | | |

Accessories

Incline Outline 24V - Adjustable | 62,5 mm

Colored filters/ Filtri colorati



Description
Square holder with colored filter/
Holder quadrato con filtro colorato
For 3X LED

Code
0.27305.00

| Finishes | |
|----------|--------|
| 4A | Red |
| 5A | Green |
| 6A | Blue |
| 7A | Pink |
| 8A | Yellow |
| 9A | Orange |

Selective filters/ Filtri selettivi



Description
Square holder with 3000K-2700K filter/
Holder con filtro 3000K-2700K
For 3X LED

Code
0.27306.0000



Description
Square holder with 2700K-2000K filter/
Holder con filtro 2700K-2000K
For 3X LED

Code
0.27309.0000



Description
Square holder with 2700K-2500K filter/
Holder con filtro 2700K-2500K
For 3X LED

Code
0.27307.0000



Description
Square holder with 3000K-3500K filter/
Holder con filtro 3000K-3500K
For 3X LED

Code
0.27310.0000



Description
Square holder with 2700K-2200K filter/
Holder con filtro 2700K-2200K
For 3X LED

Code
0.27308.0000



Description
Square holder with 3000K-4000K filter/
Holder con filtro 3000K-4000K
For 3X LED

Code
0.27311.0000

Optics accessories/ Accessori ottiche



Description
Snoot with opal filter/
Cilindro anti-abbaglio con filtro opale
For 3X LED

Code
0.27301.00

| Finishes | |
|----------|-------|
| 21 | Black |



Description
Square holder with opal lens/
Holder con lente opale
For 3X LED

Code
0.27313.0000



Description
Snoot/
Cilindro anti-abbaglio
For 3X LED

Code
0.27302.00

| Finishes | |
|----------|-------|
| 21 | Black |



Description
Square holder with spread lens/
Holder con lente prismatica
For 3X LED

Code
0.27314.0000



Description
Square holder with elliptical lens /
Holder con filtro ellittico rigato
For 3X LED

Code
0.27312.0000



Description
Square holder with honeycomb/
Holder con griglia alveolare
For 3X LED

Code
0.27325.0000

Decorative accessories/ Accessori decorativi

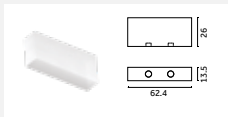

Description
Decorative frosted attachment /
Accessorio decorativo opaco
For 3X LED







Code
0.27327.0000

Incline Outline 24V - Adjustable | 125 mm









Colored filters/ Filtri colorati

| Description | Code | Finishes |
|---------------------------------------------------------------------------------------------------------------------------------------------------------------------------|-------------------|--------------------------------------------------------------------------------------------------------------------------------------------------------------------------------------------------------------------------------------------------------------------------------------------------------------------------------------------------------------------------------------------------------------------------------------------------------------------------------------------------------------------------------------------------------------------------------------------------------------------------|
|  Square holder with colored filter/ Holder quadrato con filtro colorato For 6X LED | 0.27332.00 | 4A Red  5A Green  6A Blue  7A Pink  8A Yellow  9A Orange  |

Selective filters/ Filtri selettivi

| Description | Code | Description | Code |
|-------------------------------------------------------------------------------------------------------------------------------------------------------------------------|---------------------|-------------------------------------------------------------------------------------------------------------------------------------------------------------------------|---------------------|
|  Square holder with 3000K-2700K filter/ Holder con filtro 3000K-2700K For 6X LED | 0.27333.0000 |  Square holder with 2700K-2000K filter/ Holder con filtro 2700K-2000K For 6X LED | 0.27336.0000 |
|  Square holder with 2700K-2500K filter/ Holder con filtro 2700K-2500K For 6X LED | 0.27334.0000 |  Square holder with 3000K-3500K filter/ Holder con filtro 3000K-3500K For 6X LED | 0.27337.0000 |
|  Square holder with 2700K-2200K filter/ Holder con filtro 2700K-2200K For 6X LED | 0.27335.0000 |  Square holder with 3000K-4000K filter/ Holder con filtro 3000K-4000K For 6X LED | 0.27338.0000 |

Optics accessories/ Accessori ottiche

| Description | Code | Finishes | Description | Code |
|-----------------------------------------------------------------------------------------------------------------------------------------------------------------------------|---------------------|-----------------------------------------------------------------------------------------------|------------------------------------------------------------------------------------------------------------------------------------------------------------------|---------------------|
|  Snoot with opal filter/ Cilindro anti-abbaglio con filtro opale For 6X LED | 0.27331.00 | 21  |  Square holder with opal lens/ Holder con lente opale For 6X LED | 0.27340.0000 |
|  Snoot/ Cilindro anti-abbaglio For 6X LED | 0.27328.0000 | 21  |  Square holder with spread lens/ Holder con lente prismatica For 6X LED | 0.27341.0000 |
|  Square holder with elliptical lens/ Holder con filtro ellittico rigato For 6X LED | 0.27339.0000 | |  Square holder with honeycomb/ Holder con griglia alveolare For 6X LED | 0.27329.0000 |

Decorative accessories/ Accessori decorativi

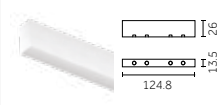
| Description | Code |
|------------------------------------------------------------------------------------------------------------------------------------------------------------------|---------------------|
|  Decorative frosted attachment / Accessorio decorativo opaco For 6X LED | 0.27342.0000 |

Linear Outline 24V



EN Linear Outline 24V - Opal is the linear lighting solution for our Outline system. It represents a non-intrusive solution that assures a comfortable, diffused lighting result. Its height, of 8mm only, guarantees complete integration within the Outline 24V track. Linear Outline 24V - Opal is available with 3 color temperatures, 2700K, 3000K and 4000K, with CRI>90.

IT Linear Outline 24V - Opal è la soluzione d'illuminazione lineare del sistema Outline. Rappresenta una soluzione d'illuminazione non intrusiva ed assicura un effetto d'illuminazione diffusa. La sua altezza, di soli 8mm, garantisce completa integrazione con i binari Outline 24V. Linear Outline 24V - Opal è disponibile con 3 temperature di colore, 2700K, 3000K, 4000K e CRI>90.



| | |
|------------------------------------|--------------------------------------------------------------------------------------------------------------------------|
| <p>Versions/ Versioni</p> | |
| <p>Linear Outline 24V Opal</p> | <div data-bbox="454 286 751 450" data-label="Image"> </div> <p data-bbox="459 521 663 544">Linear Outline 24V - Opal</p> |
| <p>IP</p> | <p>20</p> |
| <p>Control systems</p> | <p>On/Off, DALI</p> |
| <p>Insulation class</p> | <p>III</p> |
| <p>Certifications</p> | <p>CE UK ENEC</p> |

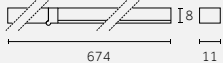
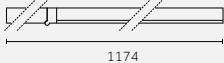
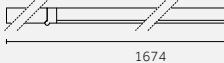

| | 674 mm | 1174 mm | 1674 mm |
|-----------------------------------------------------------------------------------|------------------------------------------------------------------------------------------------------------------------------------------------------------------------------------|---------------------------------------------------------------------------------------------------------------------------------------------------------------------------------------|---------------------------------------------------------------------------------------------------------------------------------------------------------------------------------------|
| Linear Outline 24V Opal |  |  |  |
| | p.89 | p.89 | p.89 |
|  | 115° | 115° | 115° |
| Light source/ Sorgente luminosa | MID POWER LED 7.4 W 840 lm - 945 lm L80 B10=50,000 h 2700 K; 3000 K; 4000 K SDCM <3 CRI >90 On request: QT (Tunable white) DT (Warm Dimming) | MID POWER LED 14.5 W 1680 lm - 1890 lm L80 B10=50,000 h 2700 K; 3000 K; 4000 K SDCM <3 CRI >90 On request: QT (Tunable white) DT (Warm Dimming) | MID POWER LED 21.6 W 2520 lm - 2835 lm L80 B10=50,000 h 2700 K; 3000 K; 4000 K SDCM <3 CRI >90 On request: QT (Tunable white) DT (Warm Dimming) |

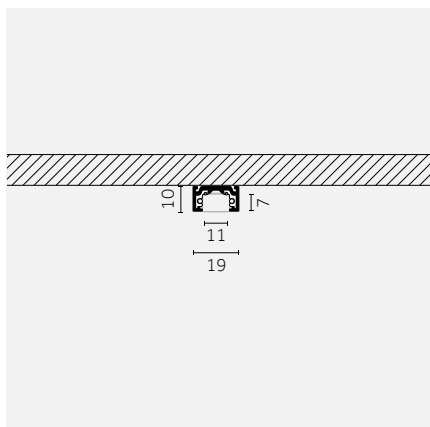

EN Linear Outline 24V in a Outline surface track.
 IT Linear Outline 24V in binario Outline Surface.

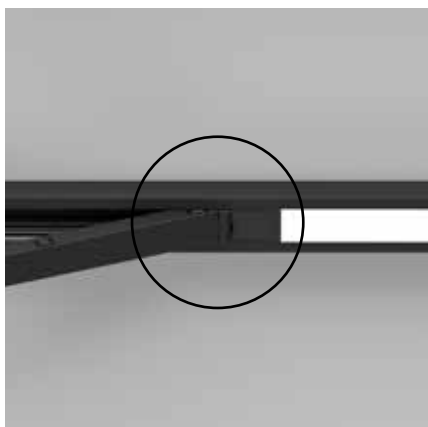

EN Easy mounting/desmouting device.
 IT Dispositivo di montaggio/smontaggio.

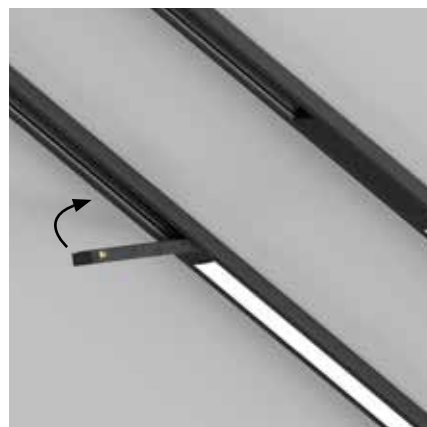

Opal | 674mm

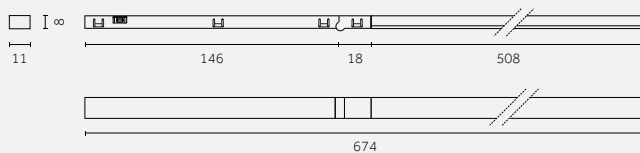

Code example:
D . BC920 . HW 00

Track Outline 24V: p.91-108
 Photometric data:
www.reggiani.net

| 7.4 W | | MID POWER LED - 14,4 W/m | | Lumen delivered up to 450 lm / Lumen maintenance: L80 B10=50,000h | | | | | | | |
|-----------------|--------------|--------------------------|----------|-------------------------------------------------------------------|-----------|------|-----|-----|------|-----------|--|
| Driver | Version | Length | Diffuser | Beam width | LED | K | CRI | lm | SDCM | Finishes | |
| 0 On-Off | BC920 | 674 mm | Opal | 115° | HW | 2700 | >90 | 840 | <3 | 00 | |
| D DALI | | | | | HQ | 3000 | >90 | 900 | <3 | | |
| | | | | | HN | 4000 | >90 | 945 | <3 | | |

LED nominal lumen
 QT (Tunable white) available soon
 DT (Warm Dimming) available soon

Opal | 1174mm

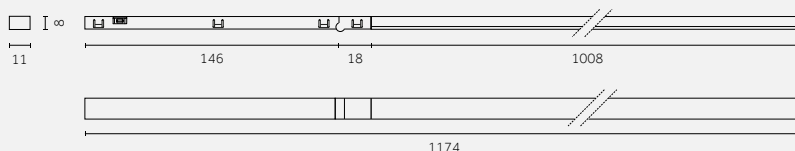

Code example:
D . BC940 . HW 00

Track Outline 24V: p.91-108
 Photometric data:
www.reggiani.net

| 14.5 W | | MID POWER LED - 14,4 W/m | | Lumen delivered up to 900 lm / Lumen maintenance: L80 B10=50,000h | | | | | | | |
|-----------------|--------------|--------------------------|----------|-------------------------------------------------------------------|-----------|------|-----|------|------|-----------|--|
| Driver | Version | Length | Diffuser | Beam width | LED | K | CRI | lm | SDCM | Finishes | |
| 0 On-Off | BC940 | 1174 mm | Opal | 115° | HW | 2700 | >90 | 1680 | <3 | 00 | |
| D DALI | | | | | HQ | 3000 | >90 | 1800 | <3 | | |
| | | | | | HN | 4000 | >90 | 1890 | <3 | | |

LED nominal lumen
 QT (Tunable white) available soon
 DT (Warm Dimming) available soon

Opal | 1674mm

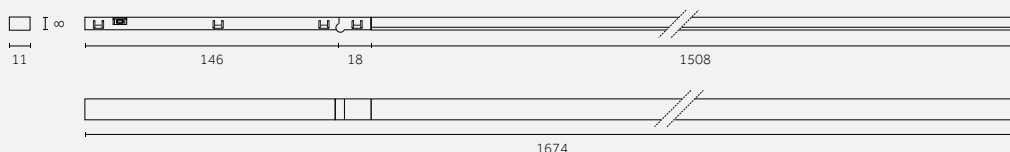
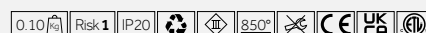

Code example:
D . BC950 . HW 00

Track Outline 24V: p.91-108
 Photometric data:
www.reggiani.net

| 21.6 W | | MID POWER LED - 14,4 W/m | | Lumen delivered up to 1351 lm / Lumen maintenance: L80 B10=50,000h | | | | | | | |
|-----------------|--------------|--------------------------|----------|--------------------------------------------------------------------|-----------|------|-----|------|------|-----------|--|
| Driver | Version | Length | Diffuser | Beam width | LED | K | CRI | lm | SDCM | Finishes | |
| 0 On-Off | BC950 | 1674 mm | Opal | 115° | HW | 2700 | >90 | 2520 | <3 | 00 | |
| D DALI | | | | | HQ | 3000 | >90 | 2700 | <3 | | |
| | | | | | HN | 4000 | >90 | 2835 | <3 | | |

LED nominal lumen
 QT (Tunable white) available soon
 DT (Warm Dimming) available soon

Track Outline

24V

Track Outline 24V
Recessed

Track Outline 24V
Surface



Track Outline 24V
Pendant

Track Outline 24V
Pendant Round









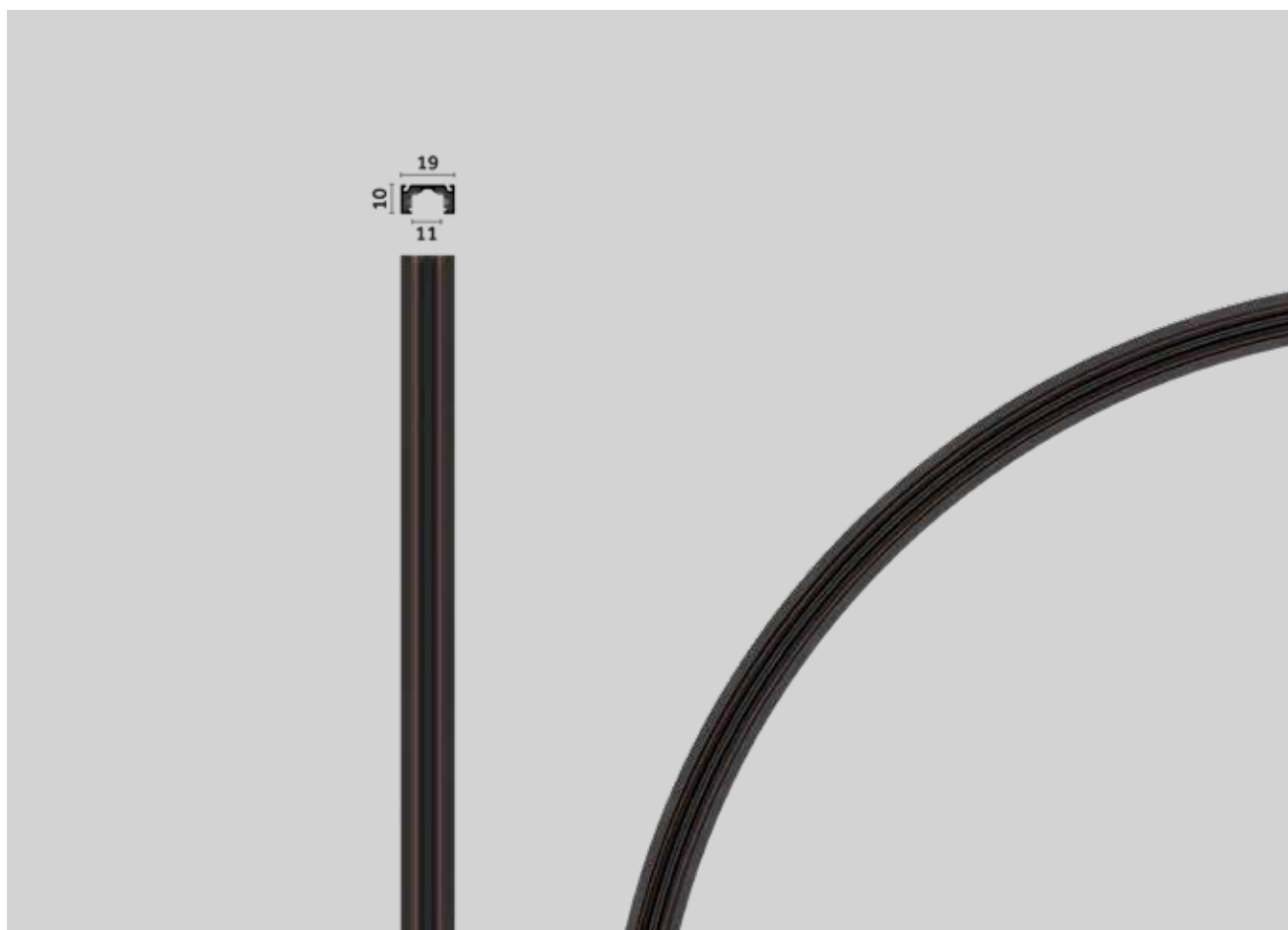







Track Outline 24V
Surface curved



EN The Outline system includes 24V track in recessed, surface and pendant configurations. A key characteristic of the system is the ability to create different, more organic configurations using the available curved options, allowing to use the track in a creative way, adapting to architectural details and personalized layouts. Outline 24V track is available in 5 different color finishes: embossed matte white, embossed matte black, brushed gold, anodized bronze and chrome.

IT Il sistema Outline comprende binari a 24V ad incasso, a superficie e a sospensione. La caratteristica chiave del sistema è la possibilità di creare diverse configurazioni: Outline 24V è infatti disponibile anche in versione curva, permettendo di utilizzare i binari in modo creativo, adattandosi a particolari dettagli architettonici o per disegnare layout personalizzati. I binari Outline 24V sono disponibili in 4 finiture colore: bianco opaco goffrato, nero opaco goffrato, oro spazzolato e bronzo anodizzato.



| | | | | |
|---------------------------------------------------------------------|-------------------------------------------------------------------------------------------------------------------------------------------------------------------------------------------------------------------------------------------------------------------------------------------------------------------------------------------------------------------------------------------------------------------------------------------------------------------------------------------------------------------------|------------------------------------------------------------------------------------------------------------------------------------------------|-------------------------------------------------------------------------------------------------------------------------------------|-------------------------------------------------------------------------------------------------------|
| Versions/ Versioni | | | | |
| Track Outline 24V |  Recessed Trimless |  Surface |  Pendant Round |  Pendant |
| Track Outline 24V Curved |  Surface Curved | | | |
| Finishes/ Finiture Special finishes/ Finiture speciali |  12 Embossed matte white/ Bianco opaco gofrato |  31 Embossed matte black/ Nero opaco gofrato |  E0 Brushed gold/ Oro spazzolato | |
| |  T1 Anodized Bronze/ Bronzo Anodizzato |  01* Chrome/ Cromo | | |
| | * On request / * Su richiesta | | | |
| IP | 20 | | | |
| Supported control systems | On/Off, DALI, Bluetooth (Casambi) | | | |
| Insulation class |  | | | |
| Certifications |       | | | |

| | | 1000 mm | 2000 mm |
|----------------------------------------|--|-----------------------------------------------------------------------------------------------------------------------|-----------------------------------------------------------------------------------------------------------------------|
| Track Outline 24V Recessed Trimless | | | |
| | | p.102 | p.102 |
| Track Outline 24V Surface | | | |
| | | p.103 | p.103 |
| Track Outline 24V Pendant | | | |
| | | p.105 / 107 | p.105 / 107 |
| Track Outline 24V Pendant Indirect | | | |
| | | p.105 / 107 | p.105 / 107 |
| ▽ | | 105° | 105° |
| Light source/ Sorgente luminosa | | MID POWER LED 14 W 1580 lm - 1825 lm L80 B10=50,000 h 2700 K; 3000 K; 4000 K SDCM <3 CRI >90 | MID POWER LED 28 W 3160 lm - 3650 lm L80 B10=50,000 h 2700 K; 3000 K; 4000 K SDCM <3 CRI >90 |

3000 mm

r 300 mm

r 500 mm

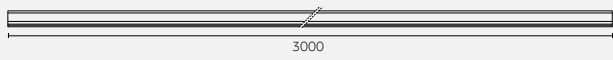

p.102

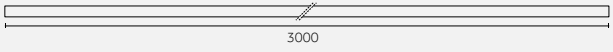

p.103

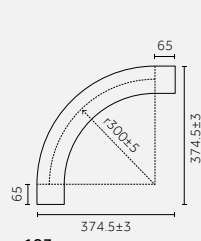

p.103

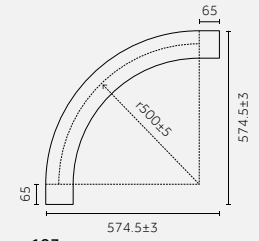

p.103

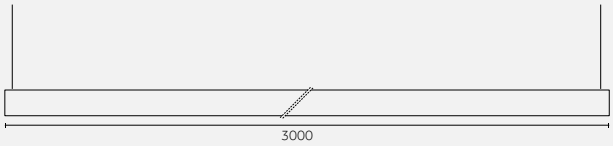

p.105 / 107

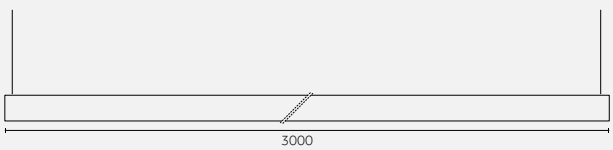

p.105 / 107

105°

MID POWER LED
42 W
4740 lm - 5475 lm
L80 B10=50,000 h
2700 K; 3000 K; 4000 K
SDCM <3
CRI >90



EN Outline Track 24V - Surface is available in curved segments.

IT Outline Track 24V - Surface è disponibile anche in segmente curvi.

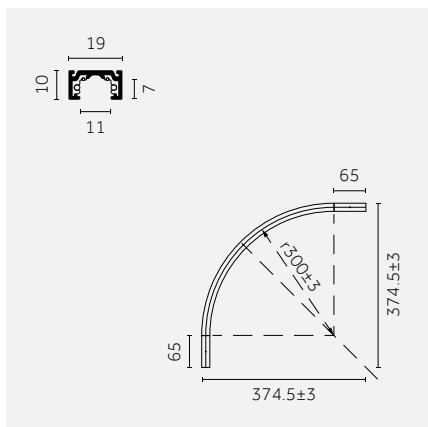

EN 300mm r curve.

IT Curva raggio 300mm.

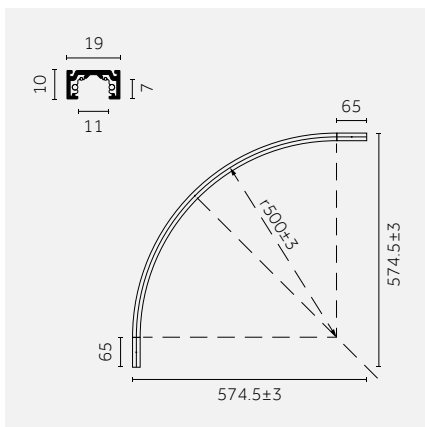

EN 500mm r curve.

IT Curva raggio 500mm.

EN Track Outline 24V Pendant is available also with indirect light. The linear LED positioned on top of the track allows to combine diffused and accent lighting. Track Outline 24V Pendant - Indirect is available in round version too, to create an infinite range of lighting configurations.

IT Track Outline 24V Pendant è disponibile anche in versione con luce indiretta. Il lineare LED posizionato nella parte superiore del binario permette di combinare illuminazione diffusa e d'accento. Track Outline 24V Pendant - Indirect è disponibile anche in versione tonda e può essere abbinato a qualsiasi apparecchio del sistema Outline 24V, per creare un'infinita gamma di configurazioni illuminotecniche.

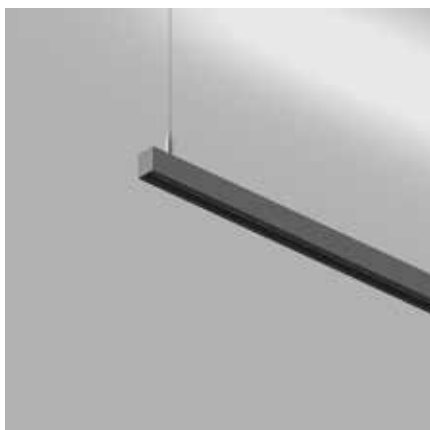

EN Outline 24V Track Pendant Indirect.
IT Binario Outline 24V Pendant Indirect.



EN Outline 24V Track Pendant Indirect - Round.
IT Binario Outline 24V Pendant Indirect - Round.

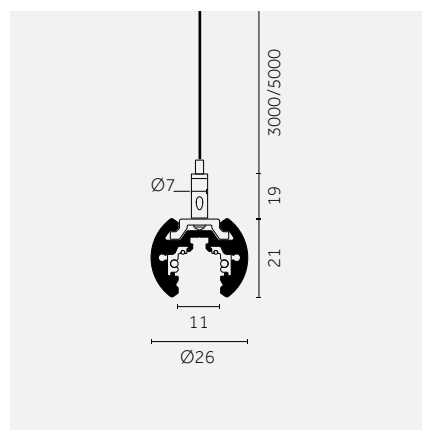

EN Outline 24V Track Pendant Indirect.
IT Binario Outline 24V Pendant Indirect.

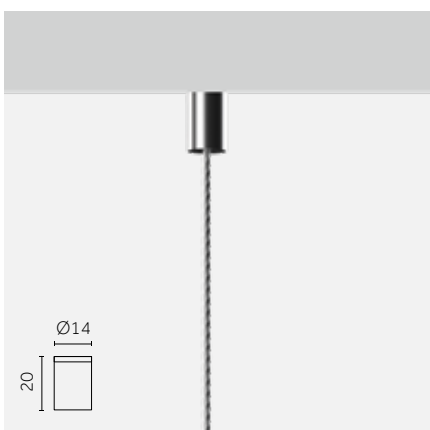

EN Pendant base.
IT Rosone.

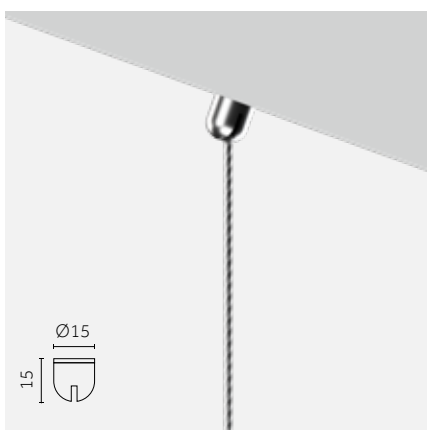

EN Adjustable pendant base.
IT Rosone orientabile.

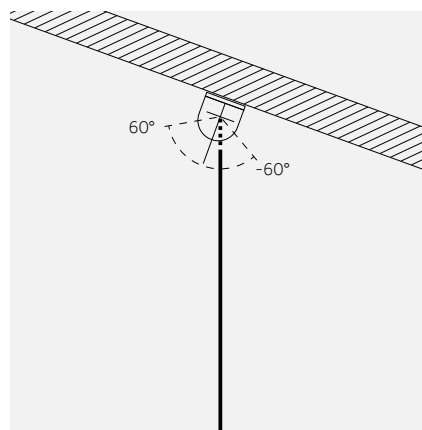

EN +/- 60° adjustability of the Track Pendant base.
IT +/- 60° di orientabilità del rosone.

Track Outline 24V

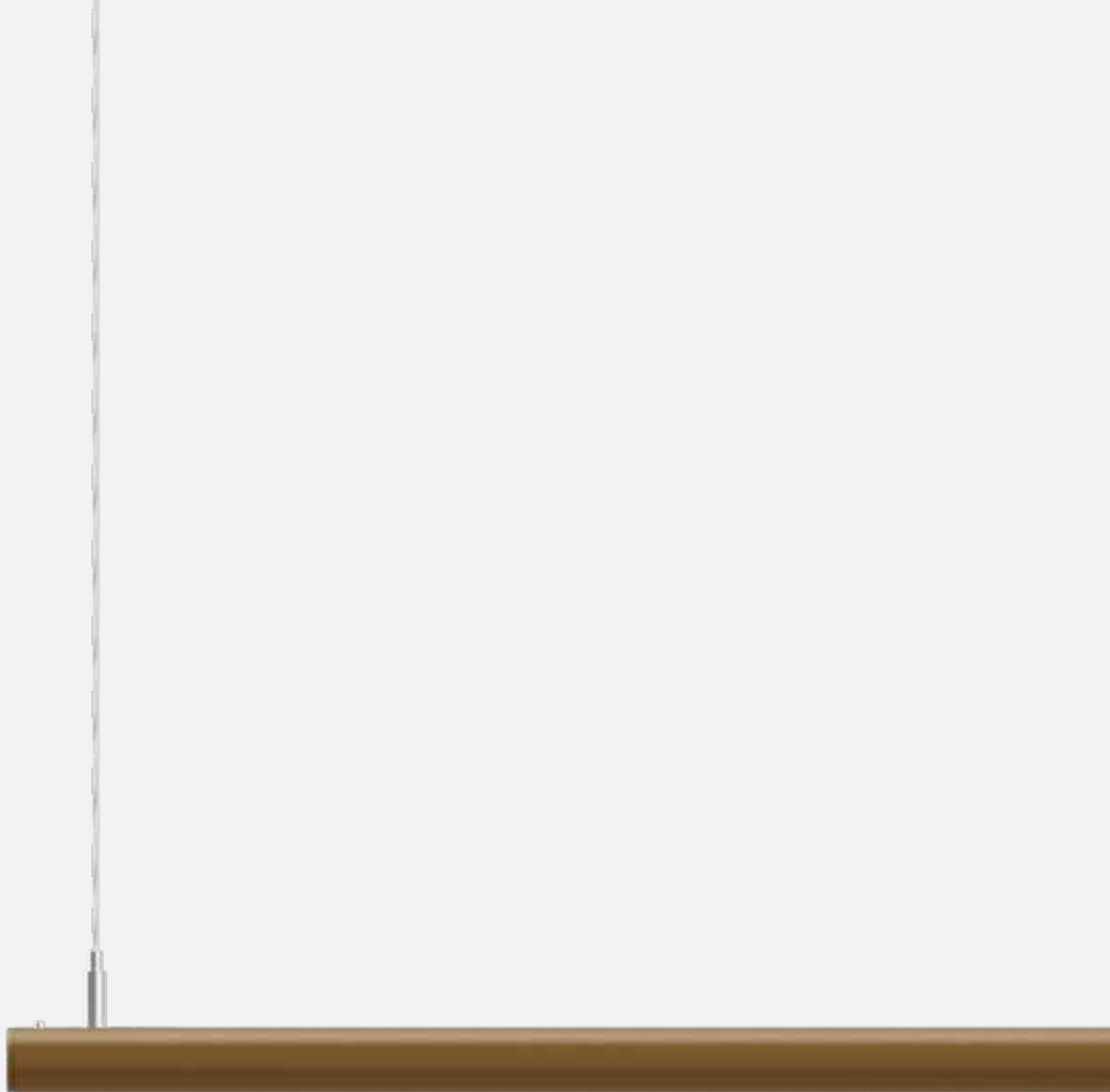

EN Outline 24V track is available in 6 different color finishes, to guarantee the maximum personalization of the project: embossed matte white, embossed matte black, brushed gold, anodized bronze and chrome.

IT I binari Outline 24V sono disponibili in 5 diverse finiture, per garantire la massima personalizzazione del progetto: bianco opaco goffrato, nero opaco goffrato, oro spazzolato, bronzo anodizzato e cromo.

Surface track

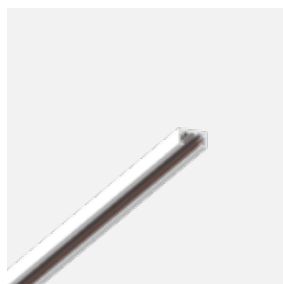

12
EN Embossed matte white/
IT Bianco opaco goffrato

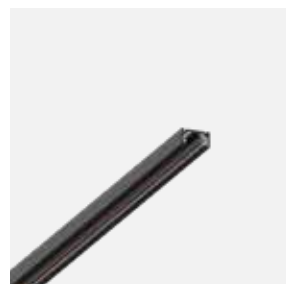

31
EN Embossed matte black/
IT Nero opaco goffrato

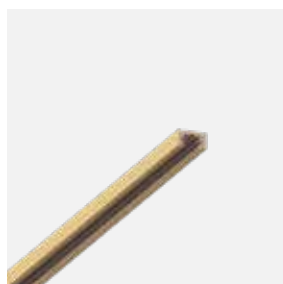

E0
EN Brushed gold/
IT Oro spazzolato

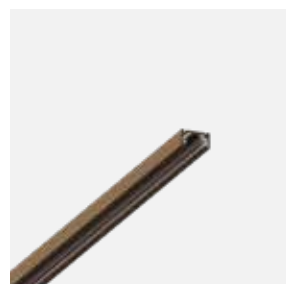

T1
EN Anodized Bronze/
IT Bronzo Anodizzato



01*
EN Chrome/
IT Cromo

Pendant track



12
EN Embossed matte white/
IT Bianco opaco goffrato



31
EN Embossed matte black/
IT Nero opaco goffrato

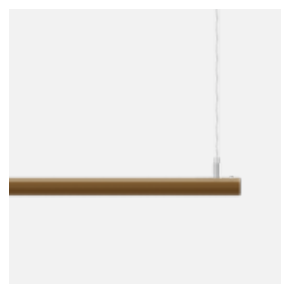

E0
EN Brushed gold/
IT Oro spazzolato



T1
EN Anodized Bronze/
IT Bronzo Anodizzato

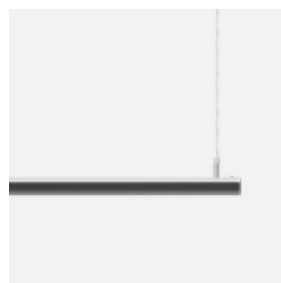

01*
EN Chrome/
IT Cromo

EN * On request
IT * Surichiesta

Recessed Trimless

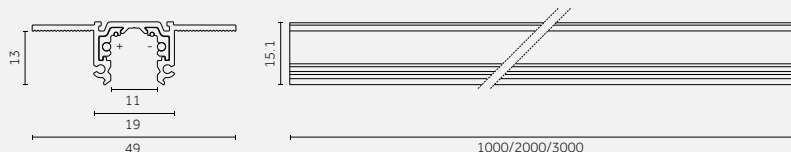

Code example:
0.02151.00 21

| Version | Length mm | Weight kg | Finishes |
|------------|-----------|-----------|----------|
| 0.02151.00 | 1000 | 0.40 | 21 |
| 0.02152.00 | 2000 | 0.80 | |
| 0.02153.00 | 3000 | 1.20 | |

Track Driver: p.109
Control systems: p.109

Recessed Trimless | Accessories

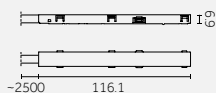
Power supply/
Alimentazioni

Description

Concealed end-feed with wire (2500mm)/
Testata di alimentazione a scomparsa con cavo (2500mm)

Code
0.02159.00

Finishes
21

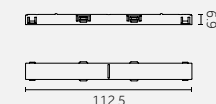
Electromechanical connections/
Conessioni elettromeccaniche

Description

Jointing connector/
Giunto passante

Code
0.02161.00

Finishes
21

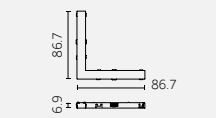

Description

L joint/
Giunto passante per angolo 90°

Code
0.02162.0021

Finishes
21

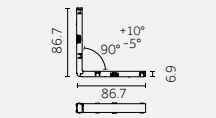

Description

L feed ceiling-wall/
Giunto a L soffitto-parete

Code
0.02163.00

Finishes
21

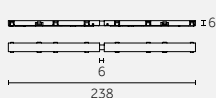

Description

Adjustable corner/
Giunto flessibile

Code
0.02166.00

Finishes
21

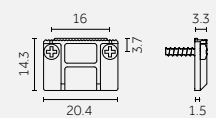
Accessories/
Accessori

Description

Plastic end cap/
Tappo di chiusura in plastica

Code
0.02164.00

Finishes
10
21

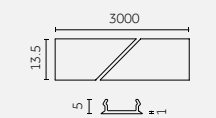

Description

Aesthetic track cover (length: 3m)/
Cover di chiusura estetica (lunghezza: 3m)

Code
0.02186.00

Finishes
10
21



Description

Locking tool for PVC to be used in case of track cutting/
Tronchese per bloccaggio PVC in caso di taglio binario

Code
0.02169.0000

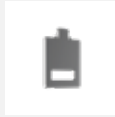

Description

Template for track installation/
Dima per installazione binario

Code
0.02187.0000

Surface

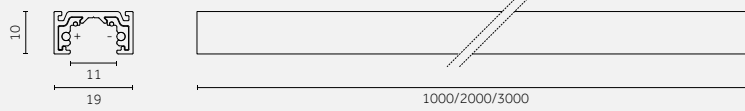

Code example:
0.02155.00 12

Track Driver: p.109
Control systems: p.109

*On request/ *Su richiesta

| Version | Length mm | Weight kg | Finishes |
|-------------------|-----------|-----------|------------|
| 0.02155.00 | 1000 | 0.30 | 12 |
| 0.02156.00 | 2000 | 0.60 | 31 |
| 0.02157.00 | 3000 | 0.90 | E0 |
| | | | T1 |
| | | | 01* |

Surface Curved

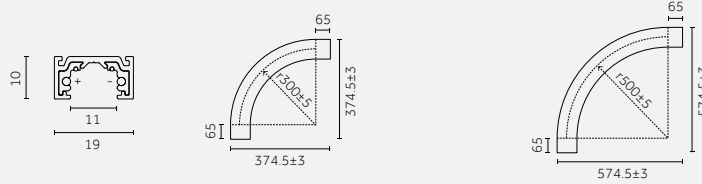

Code example:
0.02184.00 12

Track Driver: p.109
Control systems: p.109

*On request/ *Su richiesta

| Version | r mm | Weight kg | Finishes |
|-------------------|------|-----------|------------|
| 0.02184.00 | 300 | 0,17 | 12 |
| | | | 31 |
| | | | E0 |
| | | | T1 |
| | | | 01* |

| Version | r mm | Weight kg | Finishes |
|-------------------|------|-----------|------------|
| 0.02185.00 | 500 | 0,26 | 12 |
| | | | 31 |
| | | | E0 |
| | | | T1 |
| | | | 01* |

Surface | Accessories

Power supply/
Alimentazioni

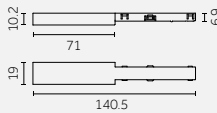

Description
End feed /
Testata di alimentazione

| Code | Finishes |
|-------------------|-----------|
| 0.02158.00 | 21 |

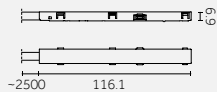

Description
Concealed end-feed with wire (2500mm)/
Testata di alimentazione a scomparsa con cavo (2500mm)

| Code | Finishes |
|-------------------|-----------|
| 0.02159.00 | 21 |

Electromechanical connections/
Connessioni elettromeccaniche

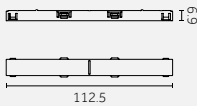

Description
Jointing connector/
Giunto passante

| Code | Finishes |
|-------------------|-----------|
| 0.02161.00 | 21 |

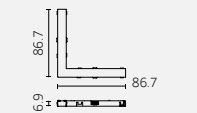

Description
L joint/
Giunto passante per angolo 90°

| Code | Finishes |
|---------------------|-----------|
| 0.02162.0021 | 21 |

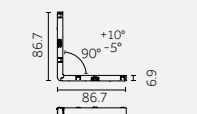

Description
L feed ceiling-wall/
Giunto a L soffitto-parete

| Code | Finishes |
|-------------------|-----------|
| 0.02163.00 | 21 |

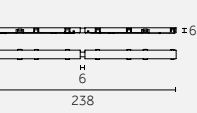

Description
Adjustable corner/
Giunto flessibile

| Code | Finishes |
|-------------------|-----------|
| 0.02166.00 | 21 |

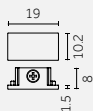
Accessories/
Accessori**Description**

Plastic end cap/
Tappo di chiusura in plastica

Code

0.02164.00

Finishes

10

21

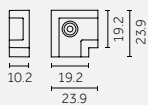
**Description**

Horizontal mechanical corner joint cover for surface track/
Coprigiunto meccanico angolare orizzontale per binario da superficie

Code

0.02167.00

Finishes

21

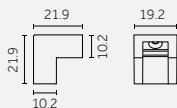
**Description**

Vertical mechanical corner joint cover for surface track/
Coprigiunto meccanico angolare verticale per binari da superficie

Code

0.02168.00

Finishes

21

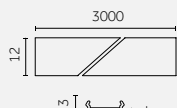
**Description**

Aesthetic track cover (length: 3m)/
Cover di chiusura estetica (lunghezza: 3m)

Code

0.02173.00

Finishes

10

21

**Description**

Locking tool for PVC to be used in case of track cutting/
Tronchese per bloccaggio PVC in caso di taglio binario

Code

0.02169.0000

Pendant

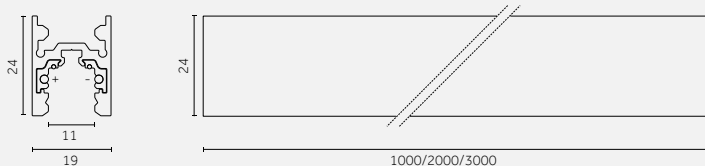

Code example:

0.02175.00 12

Track Driver: p.109

Control systems: p.109

Notes:

Kit for suspended application to be ordered separately p.107/ Kit per l'applicazione a sospensione da ordinare separatamente vedi p.107

*On request/ *Su richiesta

| Version | Length mm | Weight kg | Finishes |
|-------------------|-----------|-----------|------------|
| 0.02175.00 | 1000 | 0.60 | 12 |
| 0.02176.00 | 2000 | 1.10 | 31 |
| 0.02177.00 | 3000 | 1.60 | E0 |
| | | | T1 |
| | | | 01* |

Pendant - Indirect

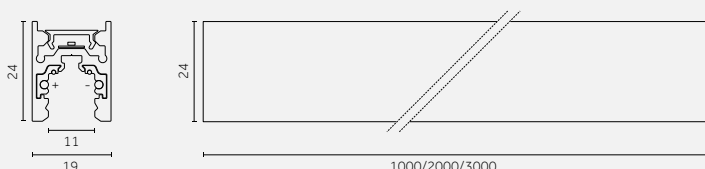

Code example:

X - 02195 - HW 12

Track Driver: p.109

Control systems: p.109

Notes:

Kit for suspended application to be ordered separately p.107/ Kit per l'applicazione a sospensione da ordinare separatamente vedi p.107

*On request/ *Su richiesta

| 14 W MID POWER LED | | Lumen delivered up to 935 lm / Lumen maintenance: L80 B10=50,000h | | | | | | | | | |
|-----------------------|---------------------|--------------------------------------------------------------------|----------|------------|-------------------|------|-----|------|------|------------|--|
| Driver | Version | Length mm | Diffuser | Beam width | LED | K | CRI | lm | SDCM | Finishes | |
| X Not included | 02195 On/Off | 1000 | Opal | 105° | HW | 2700 | >90 | 1580 | <3 | 12 | |
| | D2195 DALI | | | | HQ | 3000 | >90 | 1740 | <3 | 31 | |
| | | | | | HN | 4000 | >90 | 1825 | <3 | E0 | |
| | | | | | LED nominal lumen | | | | | T1 | |
| | | | | | | | | | | 01* | |
| 28 W MID POWER LED | | Lumen delivered up to 1869 lm / Lumen maintenance: L80 B10=50,000h | | | | | | | | | |
| Driver | Version | Length mm | Diffuser | Beam width | LED | K | CRI | lm | SDCM | Finishes | |
| X Not included | 02196 On/Off | 2000 | Opal | 105° | HW | 2700 | >90 | 3160 | <3 | 12 | |
| | D2196 DALI | | | | HQ | 3000 | >90 | 3480 | <3 | 31 | |
| | | | | | HN | 4000 | >90 | 3650 | <3 | E0 | |
| | | | | | LED nominal lumen | | | | | T1 | |
| | | | | | | | | | | 01* | |
| 42 W MID POWER LED | | Lumen delivered up to 2805 lm / Lumen maintenance: L80 B10=50,000h | | | | | | | | | |
| Driver | Version | Length mm | Diffuser | Beam width | LED | K | CRI | lm | SDCM | Finishes | |
| X Not included | 02197 On/Off | 3000 | Opal | 105° | HW | 2700 | >90 | 4740 | <3 | 12 | |
| | D2197 DALI | | | | HQ | 3000 | >90 | 5220 | <3 | 31 | |
| | | | | | HN | 4000 | >90 | 5475 | <3 | E0 | |
| | | | | | LED nominal lumen | | | | | T1 | |
| | | | | | | | | | | 01* | |

Pendant | Accessories

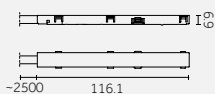
Power supply/
Alimentazioni

Description

Concealed end-feed with wire (2500mm)/
Testata di alimentazione a scomparsa con cavo (2500mm)

Code

0.02159.00

Finishes

21Electromechanical connections/
Connessioni elettromeccaniche

Description

Jointing connector/
Giunto passante

Code

0.02161.00

Finishes

21

**Description**

L joint/
Giunto passante per angolo 90°

Code

0.02162.0021

Finishes

21

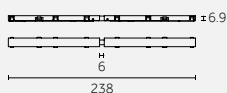
**Description**

Adjustable corner/
Giunto flessibile

Code

0.02166.00

Finishes

21

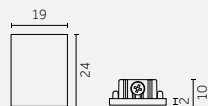
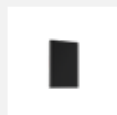
**Accessories/
Accessori****Description**

End cap for round track/
Tappo di chiusura per binario round

Code

0.02174.00

Finishes

10

21

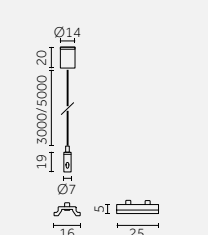
**Description**

Suspension kit with short cable bracket L3000/
Kit sospensione con staffa corta cavo L3000

Code

0.02188.00

Finishes

10

21

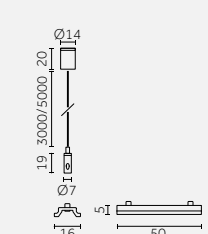
**Description**

Suspension kit with long cable bracket L3000/
Kit sospensione con staffa lunga cavo L3000

Code

0.02190.00

Finishes

10

21

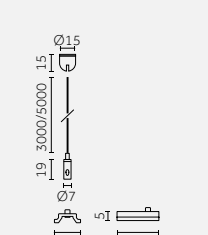
**Description**

Adjustable suspension kit with short cable bracket L3000/
Kit sospensione orientabile con staffa corta cavo L3000

Code

0.02118.00

Finishes

10

21

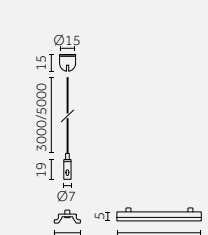
**Description**

Adjustable suspension kit with long cable bracket L3000/
Kit sospensione con staffa lunga cavo L3000

Code

0.02198.00

Finishes

10

21

**Description**

Locking tool for PVC to be used in case of track cutting/
Tronchese per bloccaggio PVC in caso di taglio binario

Code

0.02169.0000

Pendant Round

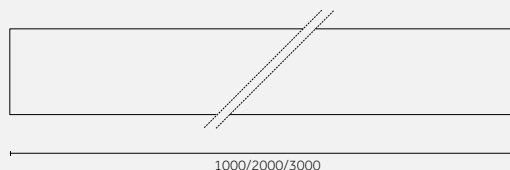
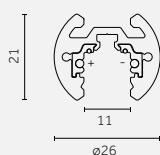

Code example:

0.02181.00 12

Track Driver: p.109

Control systems: p.109

Notes:

Kit for suspended application to be ordered separately p.108/ Kit per l'applicazione a sospensione da ordinare separatamente vedi p.108

*On request/ *Su richiesta

| Version | Length mm | Weight kg | Finishes |
|-------------------|-----------|-----------|------------|
| 0.02181.00 | 1000 | 0.70 | 12 |
| 0.02182.00 | 2000 | 1.30 | 31 |
| 0.02183.00 | 3000 | 2.00 | E0 |
| | | | T1 |
| | | | 01* |

Pendant Round - Indirect

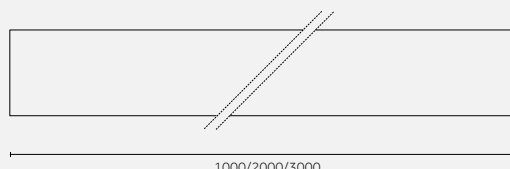
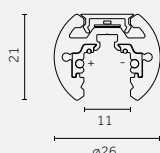

Code example:

X - 02192 - HW 12

Track Driver: p.109

Control systems: p.109

Notes:

Kit for suspended application to be ordered separately p.108/ Kit per l'applicazione a sospensione da ordinare separatamente vedi p.108

*On request/ *Su richiesta

| 14 W MID POWER LED | | Lumen delivered up to 935 lm / Lumen maintenance: L80 B10=50,000h | | | | | | | | | |
|---------------------------|---------------------|--------------------------------------------------------------------|----------|------------|-------------------|------|-----|------|------|------------|--|
| Driver | Version | Length mm | Diffuser | Beam width | LED | K | CRI | lm | SDCM | Finishes | |
| X Not included | 02192 On/Off | 1000 | Opal | 105° | HW | 2700 | >90 | 1580 | <3 | 12 | |
| | D2192 DALI | | | | HQ | 3000 | >90 | 1740 | <3 | 31 | |
| | | | | | HN | 4000 | >90 | 1825 | <3 | E0 | |
| | | | | | LED nominal lumen | | | | | T1 | |
| | | | | | | | | | | 01* | |
| 28 W MID POWER LED | | Lumen delivered up to 1869 lm / Lumen maintenance: L80 B10=50,000h | | | | | | | | | |
| Driver | Version | Length mm | Diffuser | Beam width | LED | K | CRI | lm | SDCM | Finishes | |
| X Not included | 02193 On/Off | 2000 | Opal | 105° | HW | 2700 | >90 | 3160 | <3 | 12 | |
| | D2193 DALI | | | | HQ | 3000 | >90 | 3480 | <3 | 31 | |
| | | | | | HN | 4000 | >90 | 3650 | <3 | E0 | |
| | | | | | LED nominal lumen | | | | | T1 | |
| | | | | | | | | | | 01* | |
| 42 W MID POWER LED | | Lumen delivered up to 2805 lm / Lumen maintenance: L80 B10=50,000h | | | | | | | | | |
| Driver | Version | Length mm | Diffuser | Beam width | LED | K | CRI | lm | SDCM | Finishes | |
| X Not included | 02194 On/Off | 3000 | Opal | 105° | HW | 2700 | >90 | 4740 | <3 | 12 | |
| | D2194 DALI | | | | HQ | 3000 | >90 | 5220 | <3 | 31 | |
| | | | | | HN | 4000 | >90 | 5475 | <3 | E0 | |
| | | | | | LED nominal lumen | | | | | T1 | |
| | | | | | | | | | | 01* | |

Pendant Round | Accessories

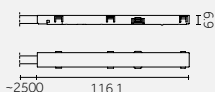
**Power supply/
Alimentazioni****Description**

Concealed end-feed with wire (2500mm)/
Testata di alimentazione a scomparsa con cavo (2500mm)

Code

0.02159.00

Finishes

21**Electromechanical connections/
Connessioni elettromeccaniche****Description**

Jointing connector/
Giunto passante

Code

0.02161.00

Finishes

21

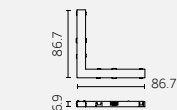
**Description**

L joint/
Giunto passante per angolo 90°

Code

0.02162.0021

Finishes

21

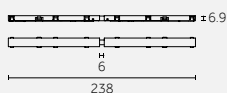
**Description**

Adjustable corner/
Giunto flessibile

Code

0.02166.00

Finishes

21

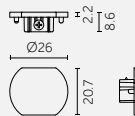
**Accessories/
Accessori****Description**

End cap for round track/
Tappo di chiusura per binario round

Code

0.02165.00

Finishes

10

21

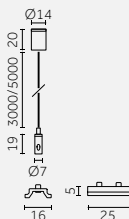
**Description**

Suspension kit with short cable bracket L3000/
Kit sospensione con staffa corta cavo L3000

Code

0.02188.00

Finishes

10

21

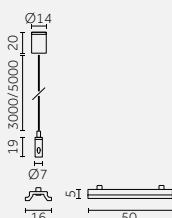
**Description**

Suspension kit with long cable bracket L3000/
Kit sospensione con staffa lunga cavo L3000

Code

0.02190.00

Finishes

10

21

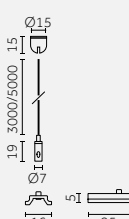
**Description**

Adjustable suspension kit with short cable bracket L3000/
Kit sospensione orientabile con staffa corta cavo L3000

Code

0.02118.00

Finishes

10

21

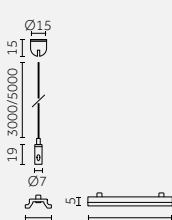
**Description**

Adjustable suspension kit with long cable bracket L3000/
Kit sospensione con staffa lunga cavo L3000

Code

0.02198.00

Finishes

10

21

**Description**

Locking tool for PVC to be used in case of track cutting/
Tronchese per bloccaggio PVC in caso di taglio binario

Code

0.02169.0000

Electrical Devices



Electrical devices

Driver/ Alimentazioni

75 W

| Type | Code | Watt | Size (mm) | Cut-out | IP | Tech. specification / Input | Output | Connectable fixtures | Max.distance | Cable section |
|--------|---------------------|------|-----------------------------------------------------------------------------------|---------|----|-----------------------------|--------|----------------------|--------------|---------------------|
| On/Off | 0.30823.0000 | 75 W |  | - | 20 | 220-240 Vac / 50/60 Hz | 24 Vdc | - | 10 m | 1.5 mm ² |

120 W

| Type | Code | Watt | Size (mm) | Cut-out | IP | Tech. specification / Input | Output | Connectable fixtures | Max.distance | Cable section |
|--------|---------------------|-------|-----------------------------------------------------------------------------------|---------|----|-----------------------------|--------|----------------------|--------------|---------------------|
| On/Off | 0.31558.0000 | 120 W |  | 80 mm | 20 | 220-240 Vac / 50/60 Hz | 24 Vdc | - | 10 m | 1.5 mm ² |
| On/Off | 0.31558.AV00 | 120 W |  | - | 65 | 120/277 Vac / 50/60 Hz | 24 Vdc | - | 10 m | 1.5 mm ² |

180 W

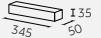
| Type | Code | Watt | Size (mm) | Cut-out | IP | Tech. specification / Input | Output | Connectable fixtures | Max.distance | Cable section |
|--------|---------------------|-------|-----------------------------------------------------------------------------------|---------|----|-----------------------------|--------|----------------------|--------------|---------------------|
| On/Off | 0.31553.0000 | 180 W |  | 62 mm | 20 | 220-240 Vac / 50/60 Hz | 24 Vdc | - | 10 m | 1.5 mm ² |

Control systems

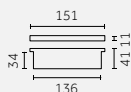

Description

Casambi Bluetooth Track Control device - 24V/
Dispositivo di controllo Casambi Bluetooth per binario - 24V

Code

H.26106.00

Finishes

21

Reggiani

©

2023

Reggiani Lighting S.r.l
All rights reserved

Art direction
Reggiani

Graphic design
Reggiani

Pictures
Reggiani
Lens visual

^{EN} Reggiani S.p.A. Illuminazione reserves the right to make technical, design and size changes at any time, without prior notice. Total or partial reproduction of this document is prohibited. Luminaire sizes are given in millimetres. All technical and design innovations are patented. Watts and lumens refer to the nominal values of the LED source; for photometric data and lumen output of the luminaires, visit www.reggiani.net

^{IT} Reggiani S.p.A. Illuminazione si riserva la facoltà di effettuare in qualsiasi momento senza preavviso, variazioni tecniche, formali e dimensionali. Sono vietate le riproduzioni anche parziali del presente documento. Le dimensioni degli apparecchi sono espresse in millimetri. Tutte le innovazioni tecniche e formali sono coperte da brevetto. Watt e lumen fanno riferimento ai valori nominali della sorgente LED, per i dati fotometrici e i lumen output degli apparecchi visitare www.reggiani.net

HEADQUARTERS
Reggiani S.p.A. Illuminazione

Viale Monza 16
20845 Sovico (MB), Italy
T. (+39) 039 20711
contact@reggiani.net



Reggiani

www.reggiani.net

[#theilluminationcollective](https://twitter.com/theilluminationcollective)