

Bring the lines to the
forefront: now you
can do more

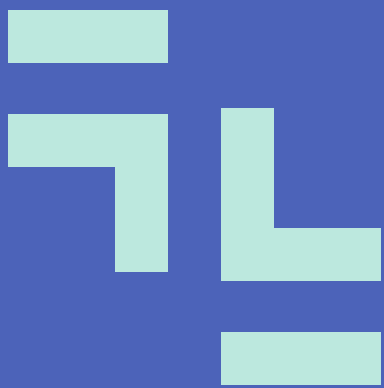

TRACELINE

Version: 2.0

Reggiani

Reggiani

Reggiani S.p.A. Illuminazione reserves the right to make technical, design and size changes at any time, without prior notice. Total or partial reproduction of this document is prohibited. Luminaire sizes are given in millimetres. All technical and design innovations are patented. Watts and lumens refer to the nominal values of the LED source; for photometric data and lumen output of the luminaires, visit www.reggiani.net

For customers and partners ordering from Germany, Traceline System products are only offered and delivered under the product name "Spoor".

Traceline

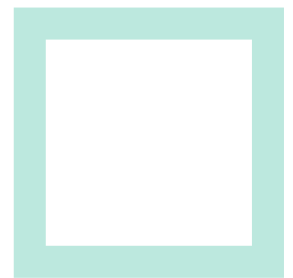
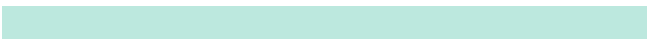



NEW



Traceline System	10
-------------------------	-----------

Optical solutions	16
--------------------------	-----------

LED	20
------------	-----------

Controls	22
-----------------	-----------

Traceline Recessed	24
--------------------	----

Traceline Surface/Pendant	28
---------------------------	----

Traceline Pendant Direct/Indirect	32
-----------------------------------	----

Angles and squares	36
---------------------------	-----------

Continuous line	42
------------------------	-----------

Traceline Track 48V	44
----------------------------	-----------

Fade	48
-------------	-----------

Finishes	50
-----------------	-----------



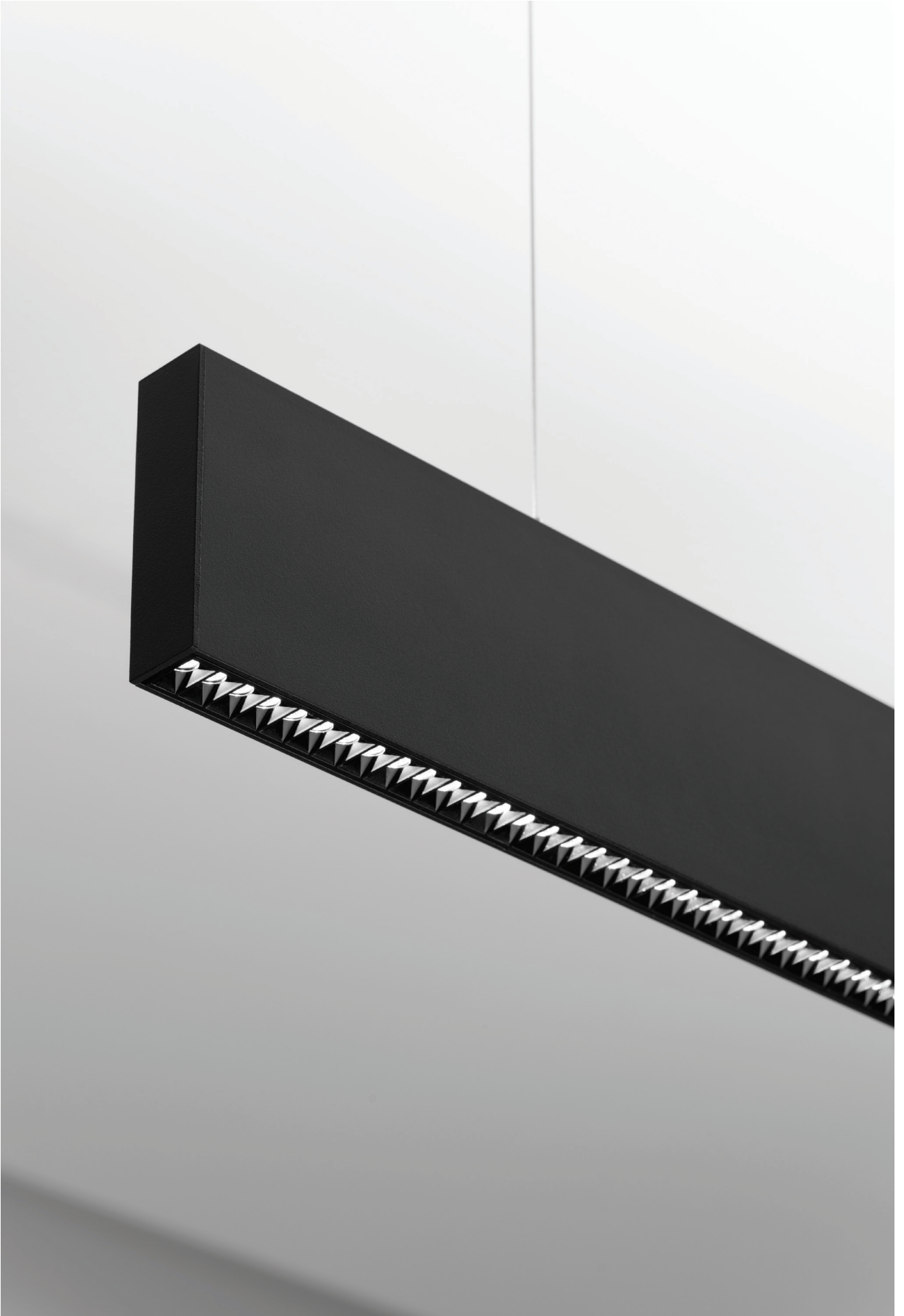

Traceline

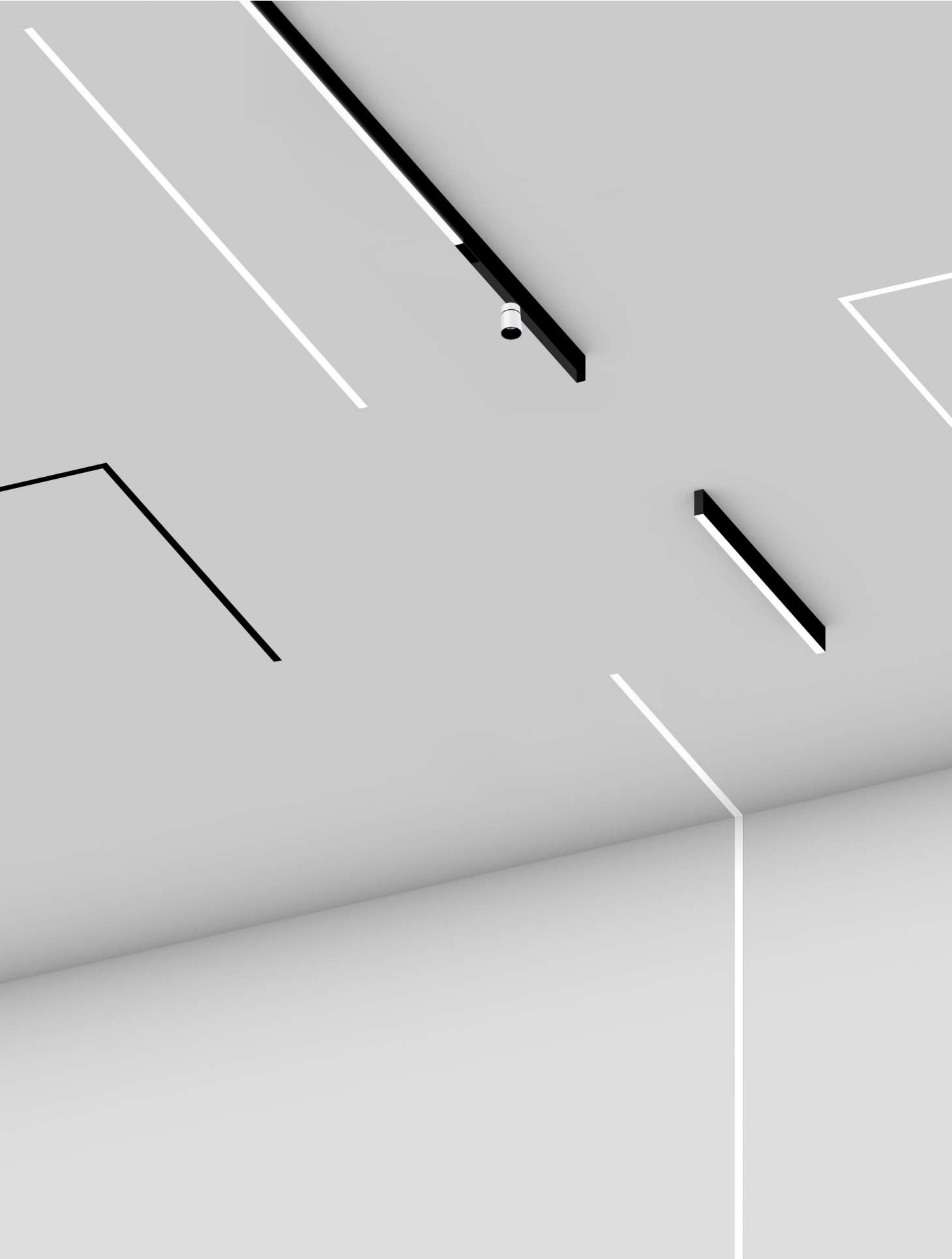

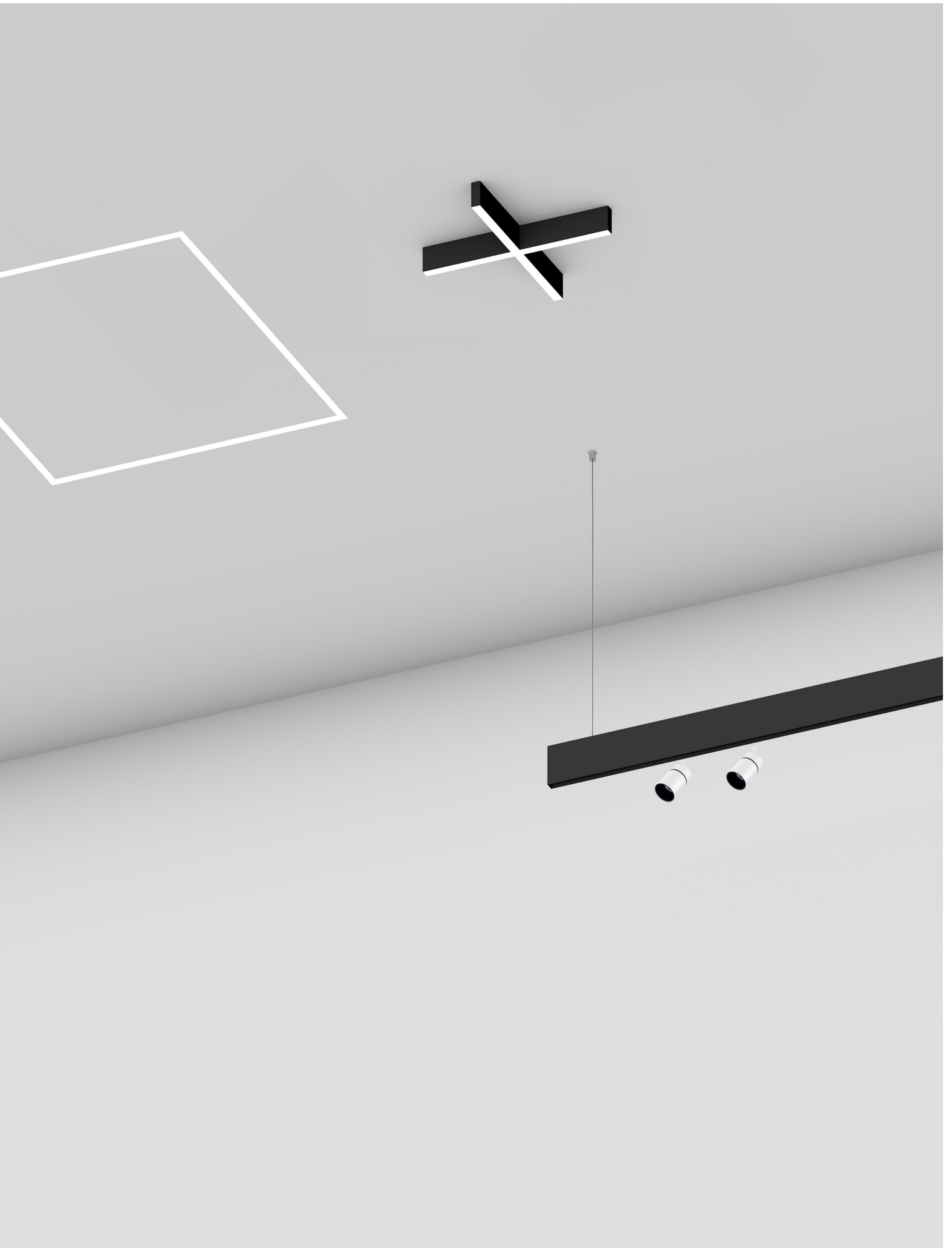

Traceline





EN Traceline has reinvented linear lighting by using the latest technology to deliver the most flexible system ever created. Traceline can be Deep Recessed, Recessed, Surface, Pendant or Deep Pendant mounted with the ability also to insert Yori 48V products. Built-in wireless controls and a variety of finishes and optical options.

IT Traceline ha reinventato l'illuminazione lineare utilizzando le più avanzate tecnologie per offrire il sistema di illuminazione lineare più flessibile mai creato. Traceline è un sistema di illuminazione lineare disponibile nella versione Deep Recessed, Recessed, Surface, Pendant e Deep Pendant - con la possibilità di inserire i prodotti a basso voltaggio Yori 48V. Il sistema offre controlli wireless integrati e una varietà di finiture e opzioni ottiche.

10

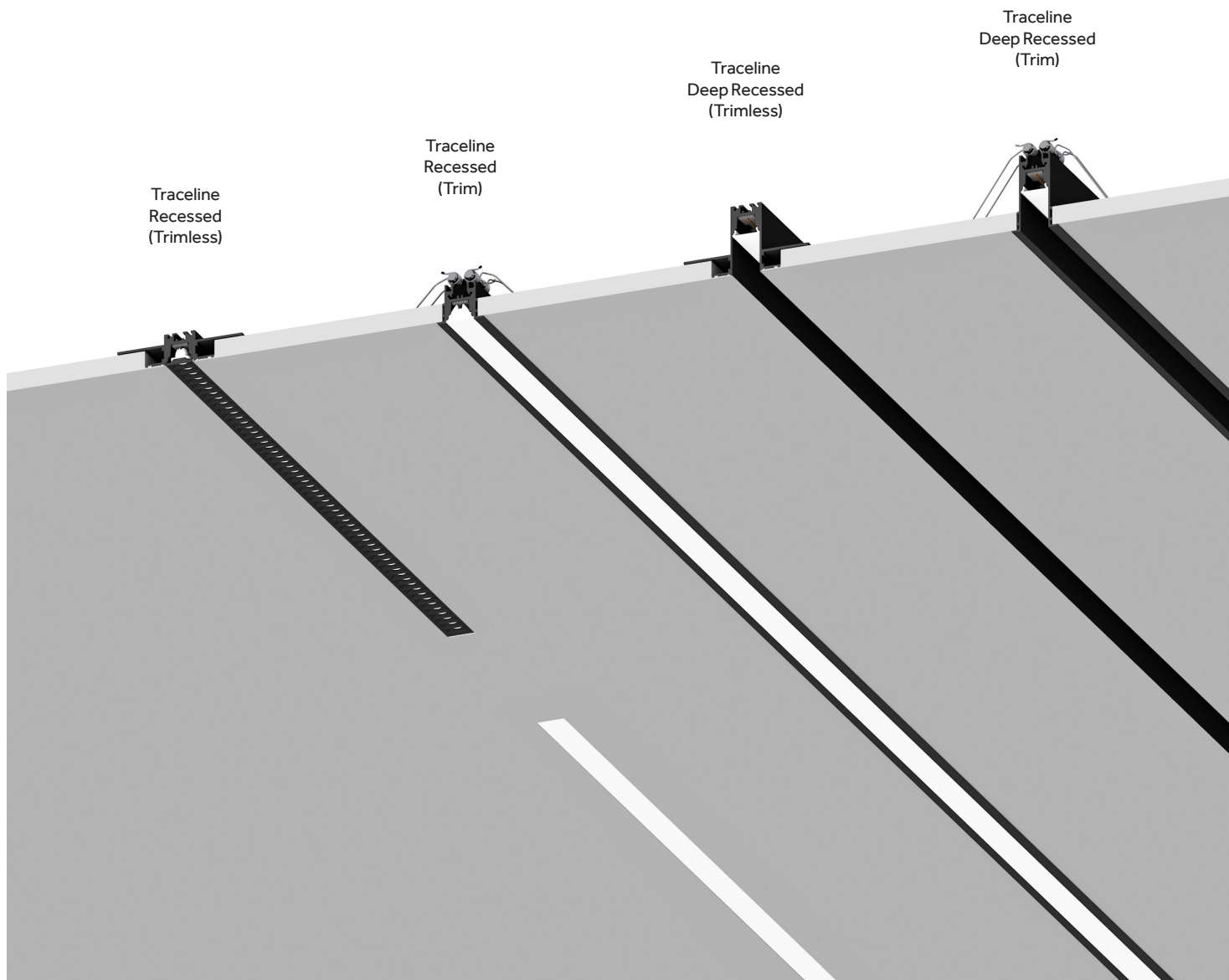



Traceline Track 48V
p.44

Traceline
Surface/Pendant

Traceline
Pendant
Direct/Indirect

Traceline
Deep Pendant
Direct/Indirect

NEW

Choose an application:

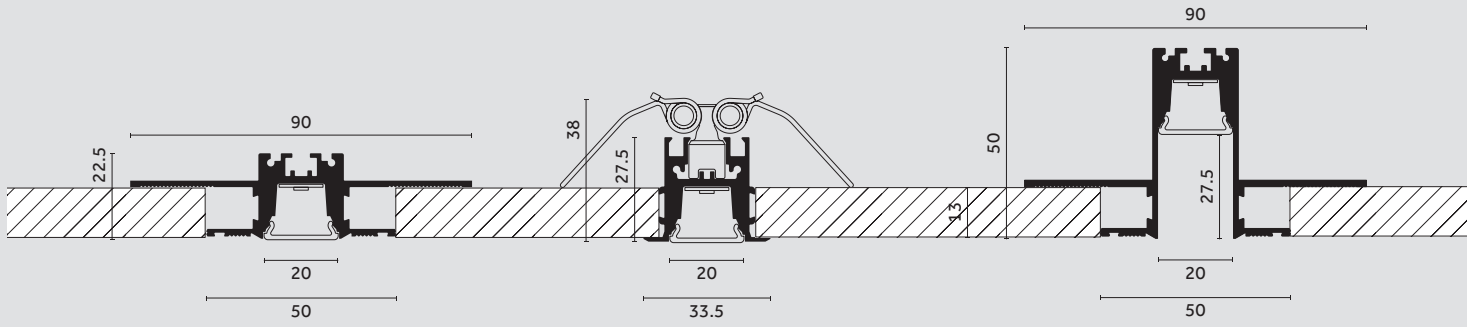

Traceline Recessed (Trimless)
p.24

Traceline Recessed (Trim)
p.24

Traceline Deep Recessed (Trimless)
p.24

Choose a length:

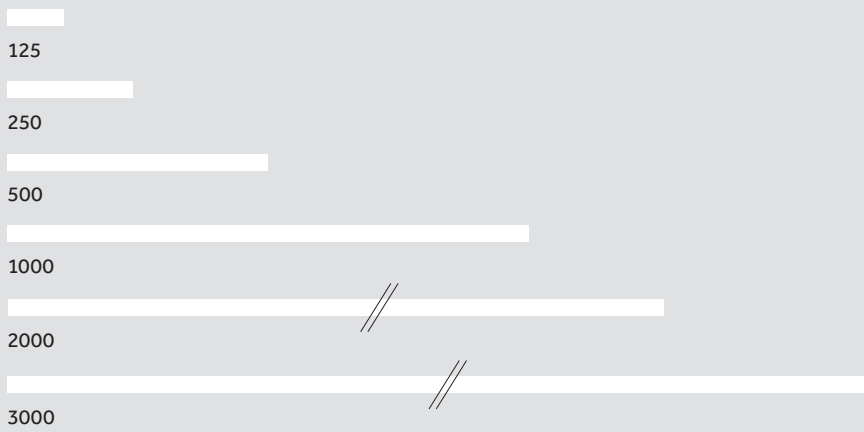

Optical solutions:



Opal High Uniformity



Dark Performance



Dark Grid



PMMA Lens (Coming soon)



Micro Prismatic

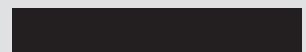

Dark Frosted

p.16

Do you need a lighting angle or a square?



250x250

500x250

500x500



250x250



500x500



750x750

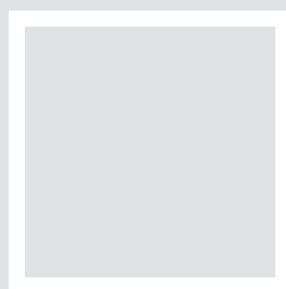

1000x1000

Angles and squares
p.36

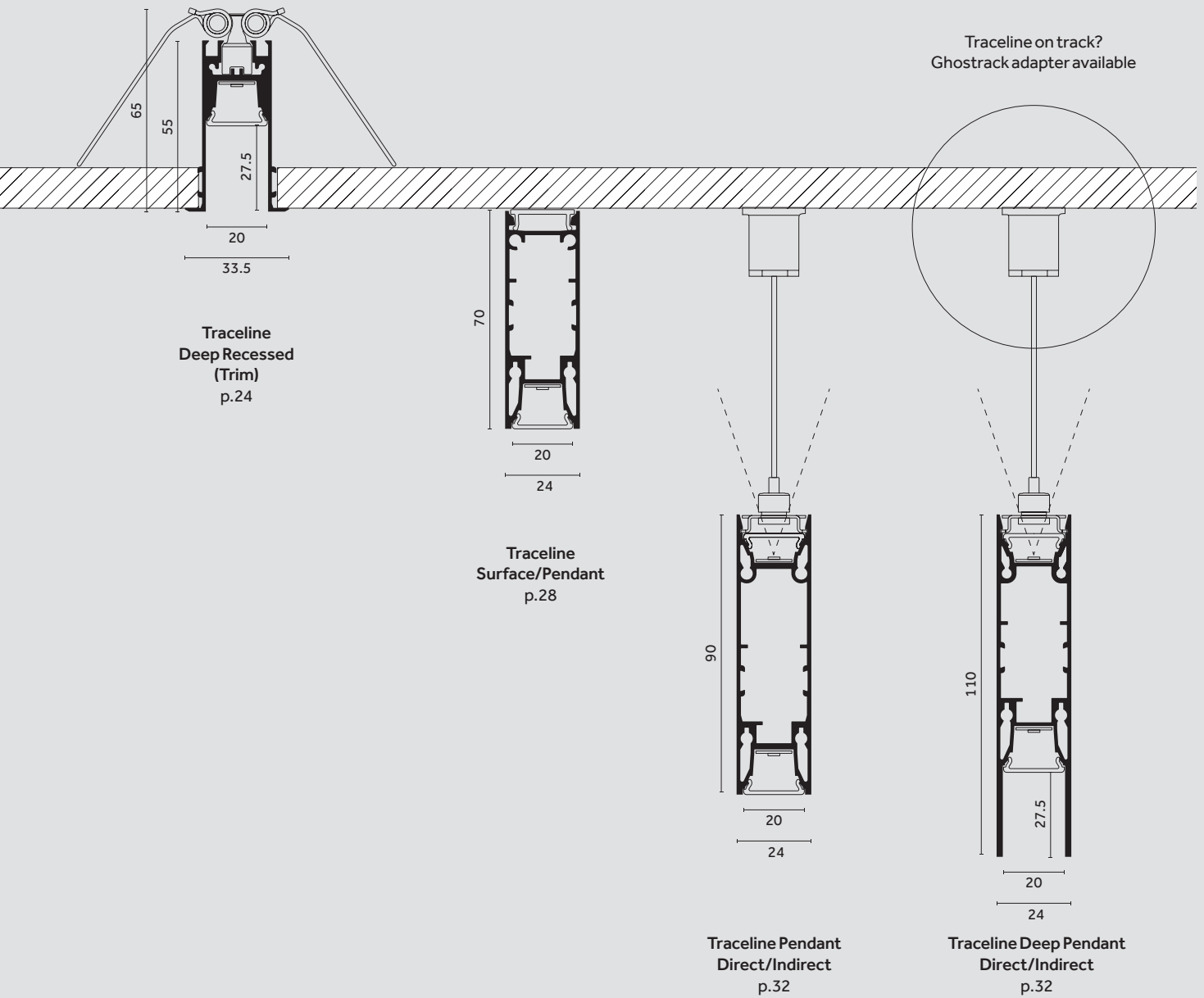

Do you want to add
a 48V product?

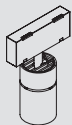

Traceline Track 48V
p.44

Complete your lighting scheme:

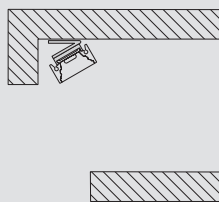

Fade
p.48

Light in your hands:



Controls
p.22

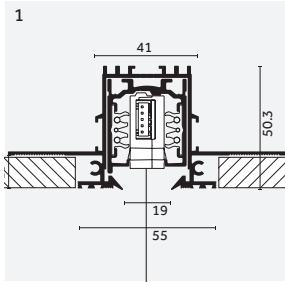

EN Ghostrack adapter
IT Adattatore Ghostrack

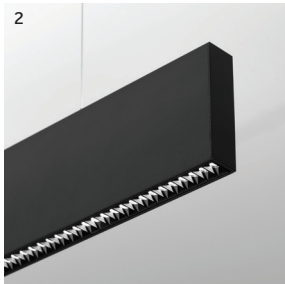

EN Diffuser: Dark Performance
IT Diffusore: Dark Performance

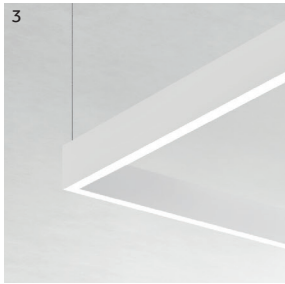

EN Traceline Pendant - Square
IT Traceline Pendant - Square



EN Traceline Surface with wall
mounting accessory
IT Traceline Surface con
accessorio montaggio a parete.

14

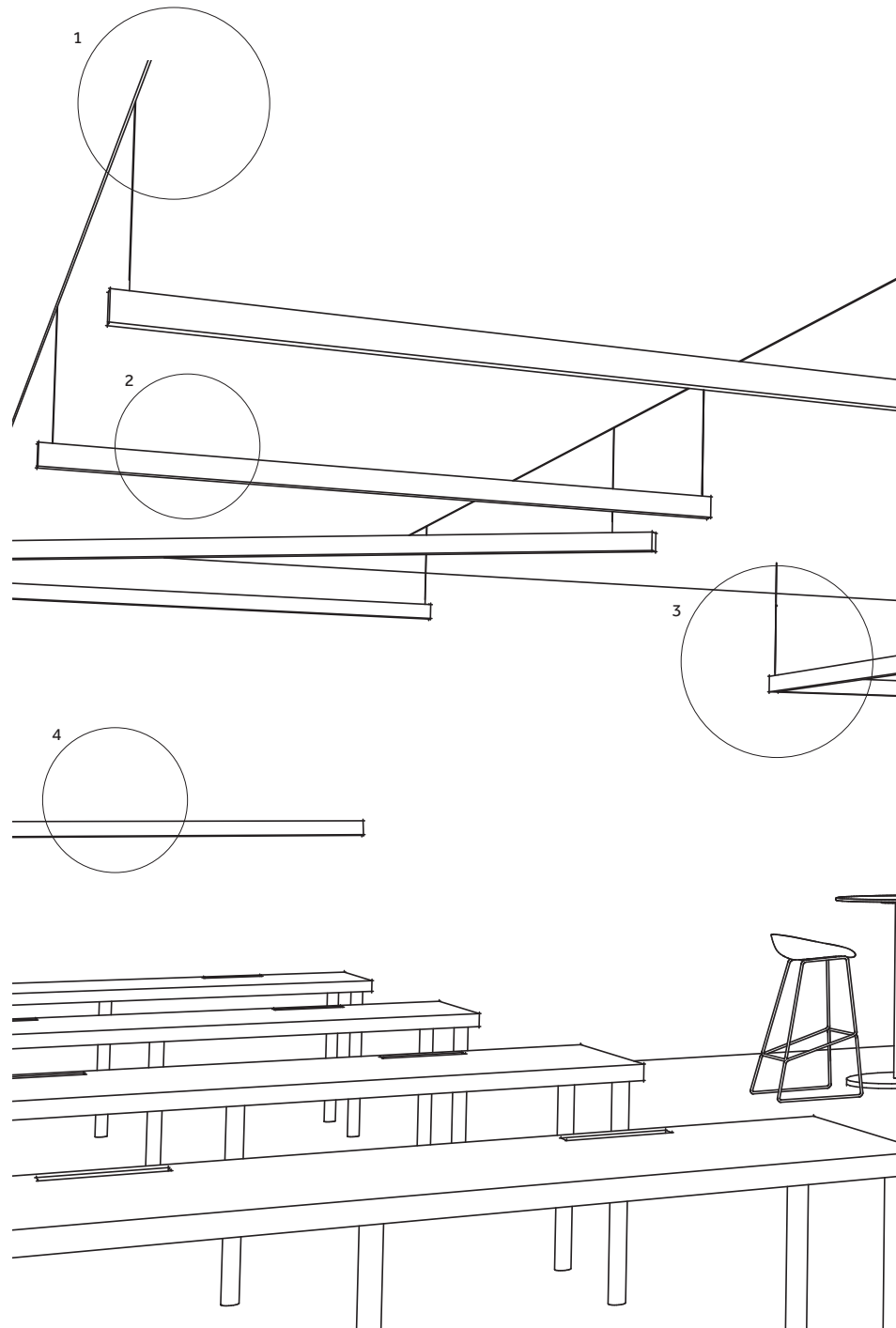

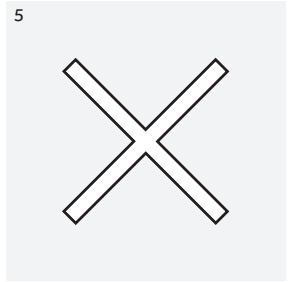
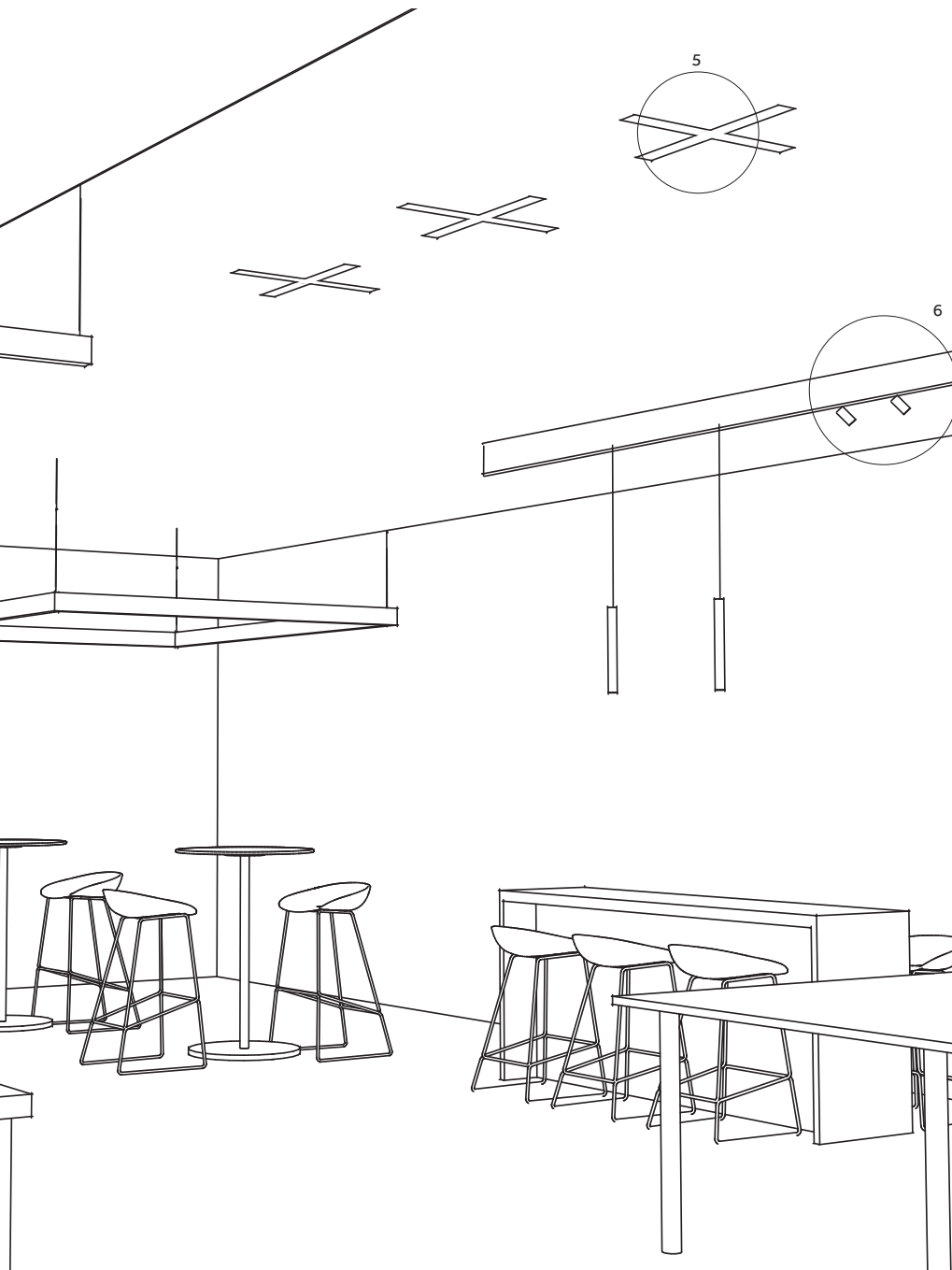

EN Traceline Recessed "X"
 IT Traceline Recessed "X"

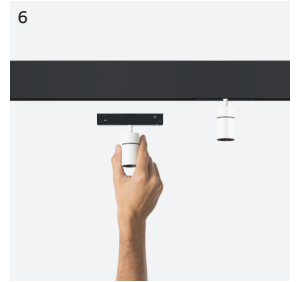

EN Traceline Track 48V
 IT Traceline Track 48V

Optical solutions

EN Traceline is available with six different optical options to offer solutions for multiple application areas: Opal with different transmittance indexes and Dark Frosted for soft and diffuse lighting; Micro Prismatic, for greater visual comfort and high efficiency; Dark Performance UGR<16 and Dark Grid UGR<14, to reduce the glare index; 48° and 11° extruded lens in PMMA with high performance for general or grazing lighting (coming soon).

IT Traceline è disponibile con sei differenti opzioni ottiche per molteplici ambiti di applicazione: Opale (differenti indici di trasmittanza) e Dark Frosted per un'illuminazione soft e diffusa; Micro Prismatico, per maggiore comfort visivo ed elevata efficienza; Dark Performance UGR <16 e Dark Grid UGR <14, per ridurre l'indice di abbagliamento; Lente estrusa 48° e 11° in PMMA dalle alte performance per l'illuminazione generale diffusa o radente (coming soon).

16

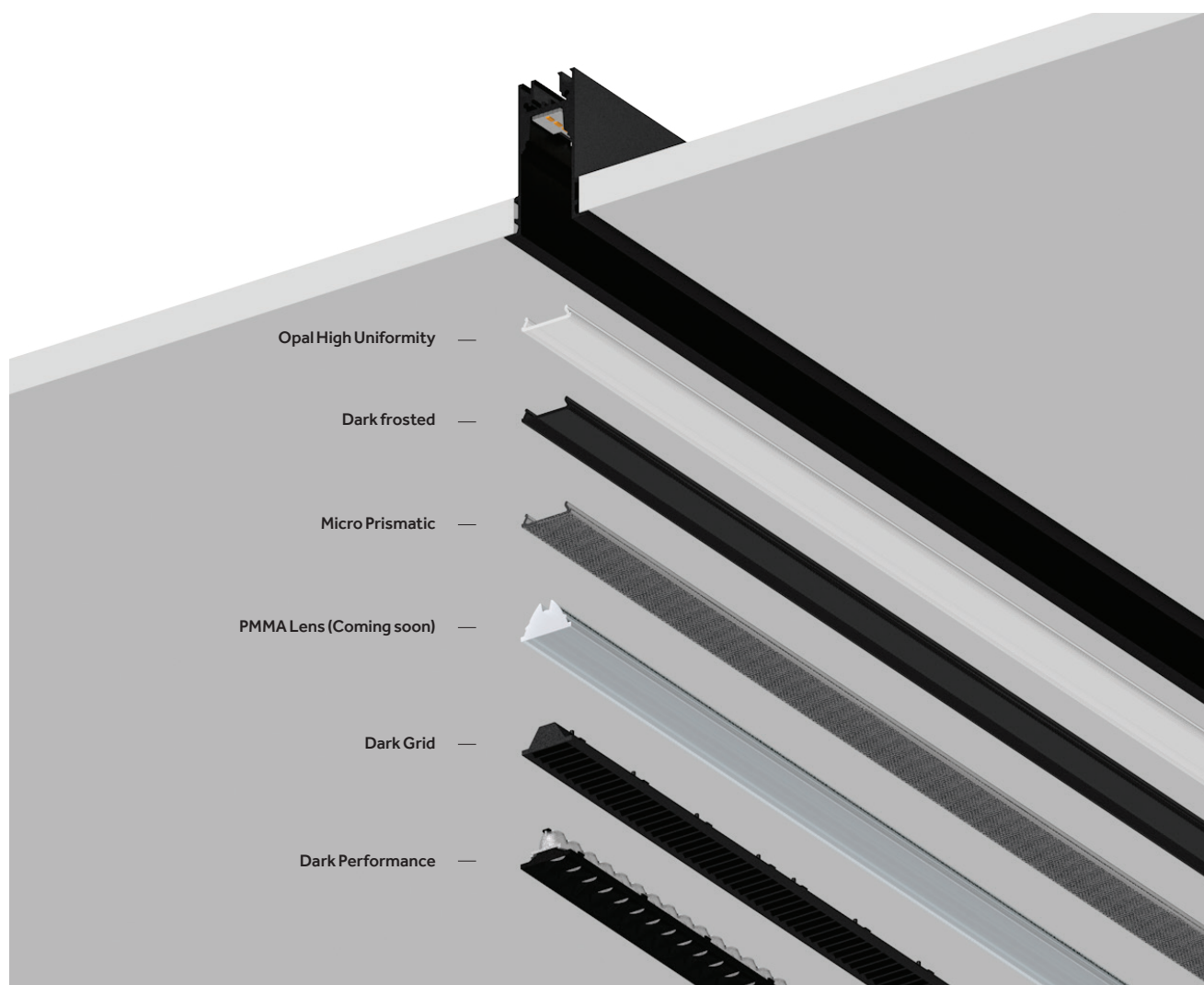

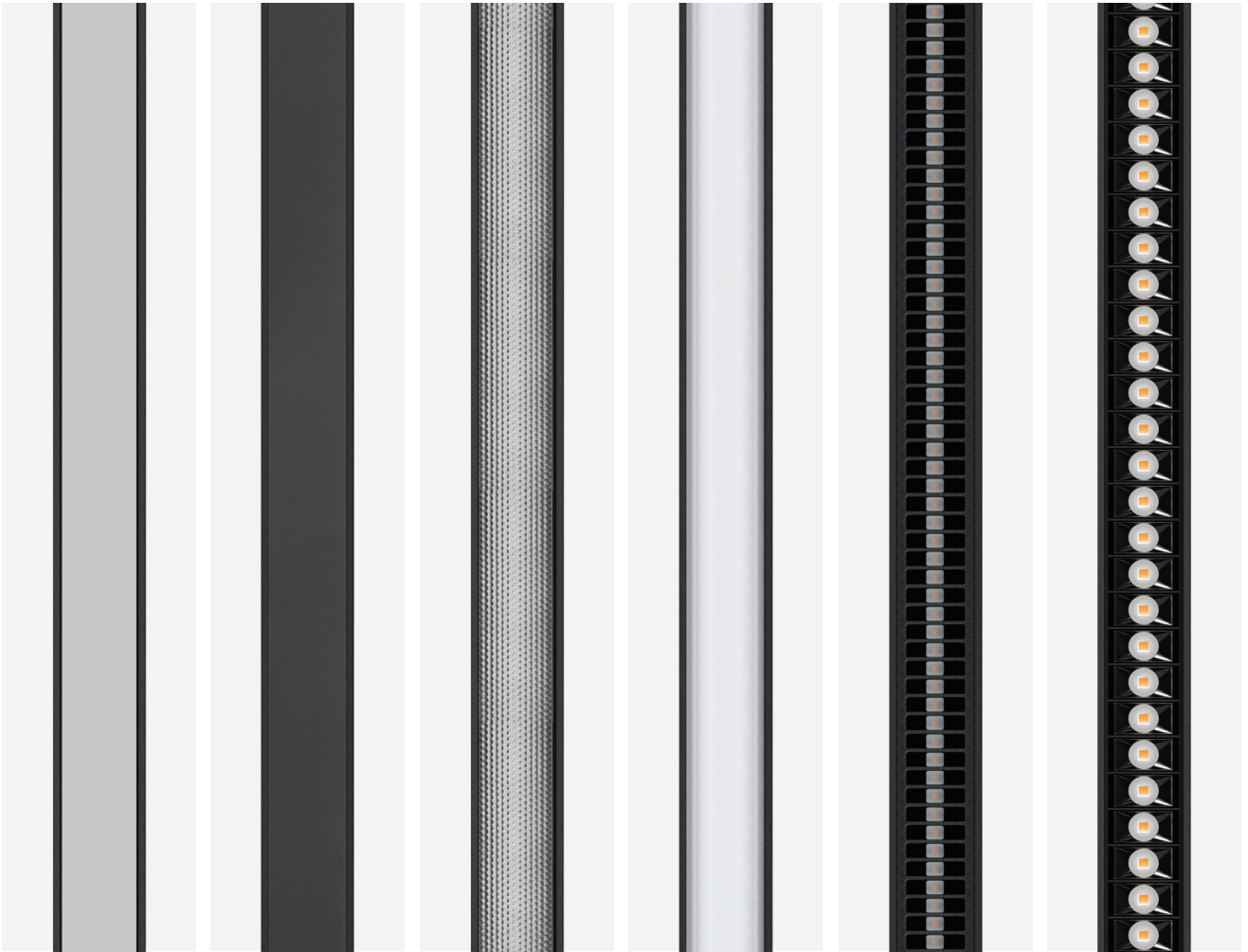

Opal High Uniformity (110°)

Dark Frosted (90°)

Micro Prismatic (70°/90°)

**PMMA Lens (11°)
Coming soon**

Dark Grid (60°/20°)

Dark Performance (40°)

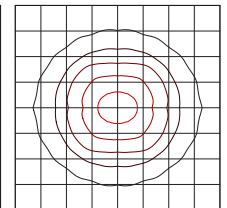
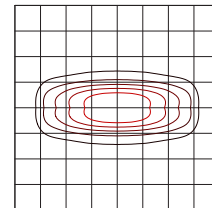
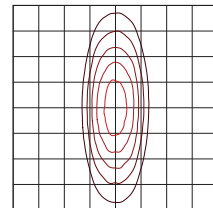
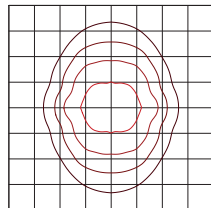
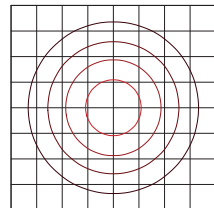
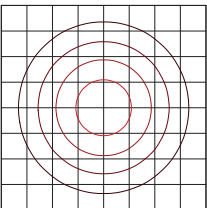

Direct Light
T 55%
Efficacy up to 88 Lm/W
Indirect Light
T 70%
Efficacy up to 96 Lm/W

Matt Black finish

Low Glare
Efficacy up to 73 Lm/W

High Performance
Extruded PMMA

UGR<14
Cross Oval

UGR<16
Efficacy up to 70 Lm/W

**PMMA Lens (48°)
Coming soon**

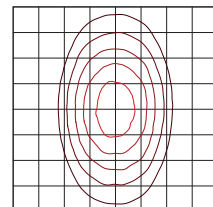

High Performance
Extruded PMMA



18

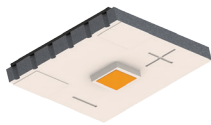

EN MID POWER LED with excellent performances and high colour rendering CRI>90 and CRI>95, less sensible to the quantitative reduction of phosphors on the diode, main cause of colour over angle.

IT MID POWER LED dalle prestazioni eccellenti e resa cromatica elevata CRI>90 e CRI>95, meno sensibili alla riduzione quantitativa dei fosfori sul diodo, causa principale del color over angle.



EN PMMA collimator micro lens with surface treatment for maximum colour homogeneity throughout all distribution width and for protection of the light source from dust and dirt.

IT Micro lente collimatrice in PMMA con trattamento superficiale per la massima omogeneità del colore per tutta l'ampiezza della distribuzione e per protezione della sorgente luminosa da polvere e sporcizia.

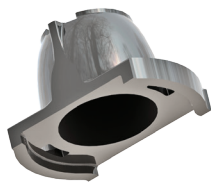

EN Reflector in metallic mirrored thermoplastic for high cut-off and reduction of the portion of uncontrolled direct light.

IT Riflettore in termoplastica metallizzata specchiata per elevato cut-off e riduzione della porzione di luce diretta non controllata

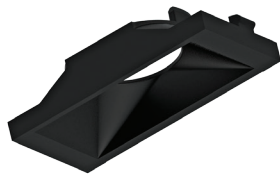

EN Glossy black plastic screen for glare reduction and lower UGR values.

IT Schermo in plastica nera lucida per riduzione dell'abbaglio e valori UGR più contenuti

Colour over angle



^{EN} Thanks to the newly developed optical solution, Dark Performance reflectors ensure a homogeneous illuminance without chromatic distortions on the whole width of the light distribution and a glare control with UGR values <16.

^{IT} Grazie alla soluzione ottica sviluppata, i riflettori Dark Performance assicurano un illuminamento omogeneo senza distorsioni cromatiche sull'intera ampiezza della distribuzione luminosa e un controllo dell'abbaglio con valori UGR<16

19

Dark Performance

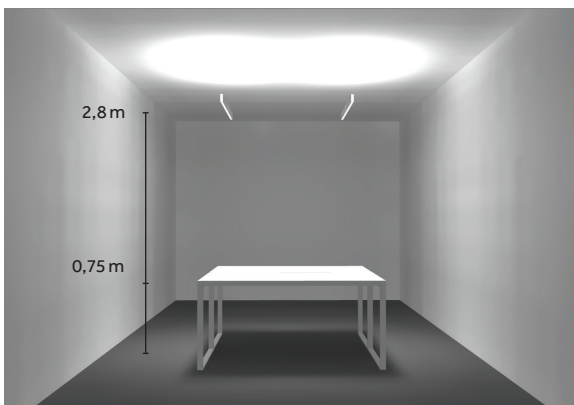

Product: Traceline Pendant Direct/Indirect
Product Length: 2 x 1000 mm
Diffuser: Dark Performance
LED: 3000 K
Power (Indirect light): 2 x 28 W
Power (Direct light): 2 x 21 W

Surface area 1,6 m x 1,6 m
Average illuminance >500 lx
Uniformity 0.58
Glare 65°, <240 cd/m²
UGR Trasversal <17
UGR Axial <17

Dark Grid

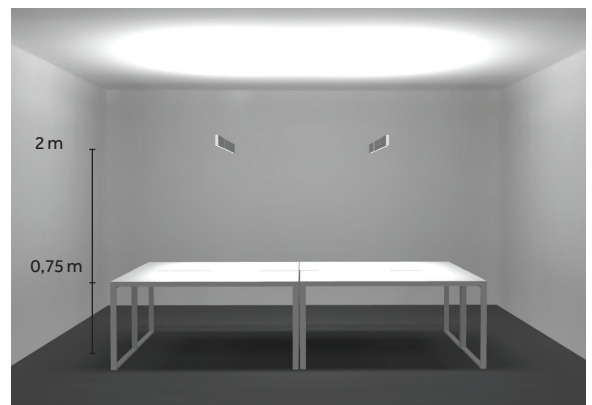

Product: Traceline Pendant Direct/Indirect
Product Length: 2 x 1500 mm
Diffuser: Dark Grid
LED: 3000 K
Power (Indirect light): 2 x 42 W
Power (Direct light): 2 x 42 W

Surface area 1,6 m x 3,2 m
Average illuminance >500 lx
Uniformity 0.5
Glare 65°, 35 cd/m²
UGR Trasversal <10
UGR Axial <10

LED

EN Traceline offers excellent performances thanks to the integration of latest generation light sources. The range includes Mid Power LEDs, with performance up to 170lm/w, High output and Mid output versions, options with high CRI > 95 and dynamic-white versions: Warm Dimming 1800-2700K and Tunable White 2200-6500K.

IT Traceline offre performance eccellenti grazie all'integrazione di sorgenti luminose di ultima generazione. La gamma proposta include LED Mid Power con performance fino a 170lm/w, versioni High output e Mid output, opzioni con CRI elevato >95 e versioni con bianco dinamico: Warm Dimming 1800-2700K e Tunable White 2200-6500K.

MID POWER LED

20

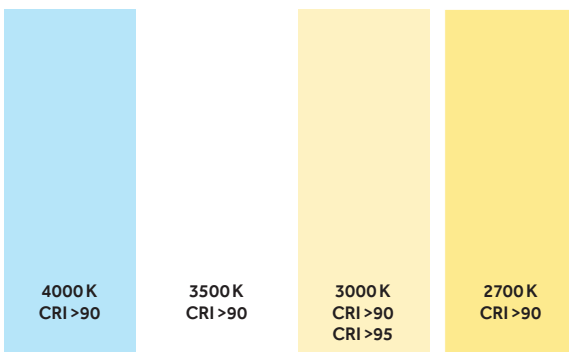

EN Different solutions with Mid Power LED:
IT Differenti soluzioni con LED Mid Power:

- 224 LED/m, 150 lm/w (Opal, Micro Prismatic, Dark Grid, PMMA Lens 11°/48°)
- 112 LED/m, 170 lm/W (Dark Performance)
- Warm Dimming, Tunable White (Opal)
- LED tape IP20 CRI>95 and IP65 CRI>90. (Fade)

EN Wide range of LED temperatures:

- from 4000 K to 2700K with CRI>90 and 3000K options with CRI>95.
- Step Mc Adam < 3 and L80 B50: 50.000h
- Version with Opal diffuser (High output and Mid output) to meet different lighting needs.

IT Ampia gamma di temperature LED:

- da 4000 K a 2700K con CRI>90 e opzioni a 3000K con CRI>95.
- Step Mc Adam < 3 e L80 B50: 50.000h
- Versione con diffusore Opal (High output e Mid output) per rispondere ad esigenze di illuminamento differenti.



EN The Dark Performance optical version is available with HCL LED (CRI > 95) - 3000K (on request for other CCTs). Thanks to an excellent color rendering and TM30 values of Rg = 90 and Rf = 100 it allows the use of Traceline also in commercial and residential applications where a very high CRI value is required.

IT La versione ottica Dark Performance è disponibile con LED HC (CRI > 95) - 3000K (a richiesta per altri CCT). Con un'eccellente resa cromatica e valori TM30 di Rg=90 e Rf=100 permette l'utilizzo di Traceline anche in applicazioni commerciali e residenziali dove viene richiesto un valore di CRI molto elevato.

Warm Dimming



2700K

1800K

EN Warm dimming: one channel control
IT Warm dimming: controllo a un canale

21

Tunable White

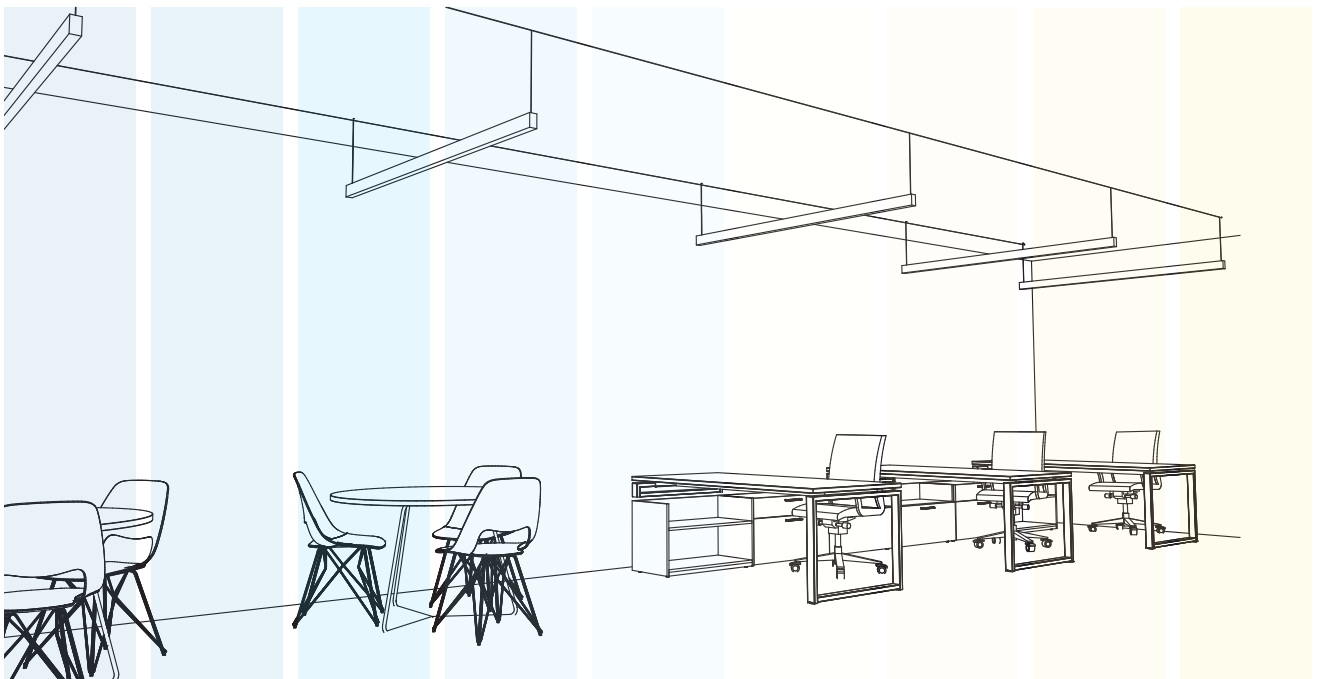

6500K

2700K

EN Tunable White: two channels control
IT Tunable White: controllo a due canali

Traceline

Light in your hands

^{EN} Traceline offers multiple control options, integrated or remote. The standard protocols available are: On/Off, DALI, Dimm 1-10 V (some versions available in Push Dimm) and Bluetooth. Traceline Surface, Pendant and Deep Pendant offer all control options integrated for both single and continuous applications and allow you to control standard CCTs or Dynamic white options (Warm Dimming or Tunable White).

^{IT} Traceline offre molteplici opzioni di controllo, integrate o remote. I protocolli standard disponibili sono: On/Off, DALI, Dimm 1-10 V (alcune versioni disponibili in Push Dimm) e Bluetooth. Traceline Surface, Pendant e Deep Pendant offrono tutte le opzioni di controllo integrate, sia per applicazione singola che in linea continua e permettono di controllare opzioni con CCT standard o con bianco dinamico (Warm Dimming o Tunable White).

22

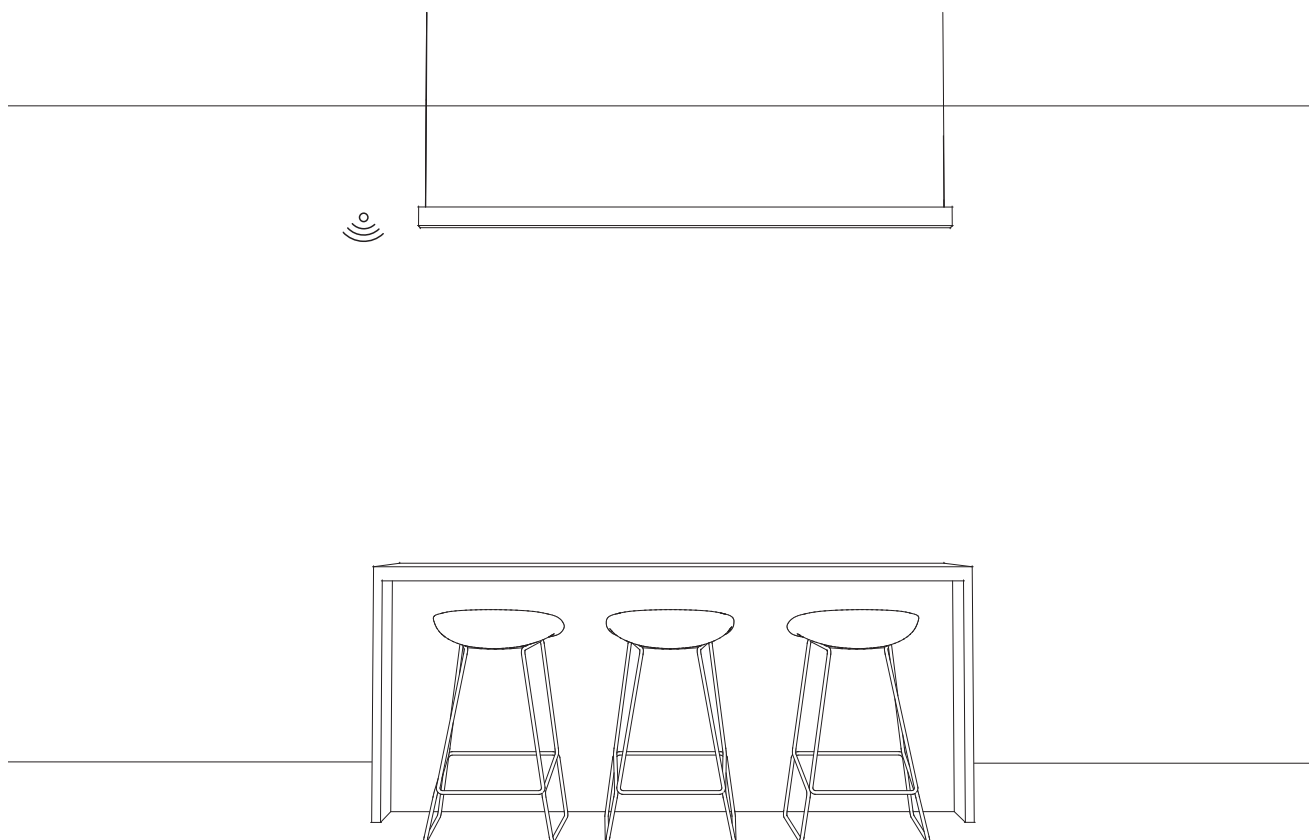

Controls
On/Off
DALI
Dimm 1-10 (Push Dimm)
Bluetooth

^{EN} Traceline Pendant - Single module
^{IT} Traceline Pendant - Modulo singolo

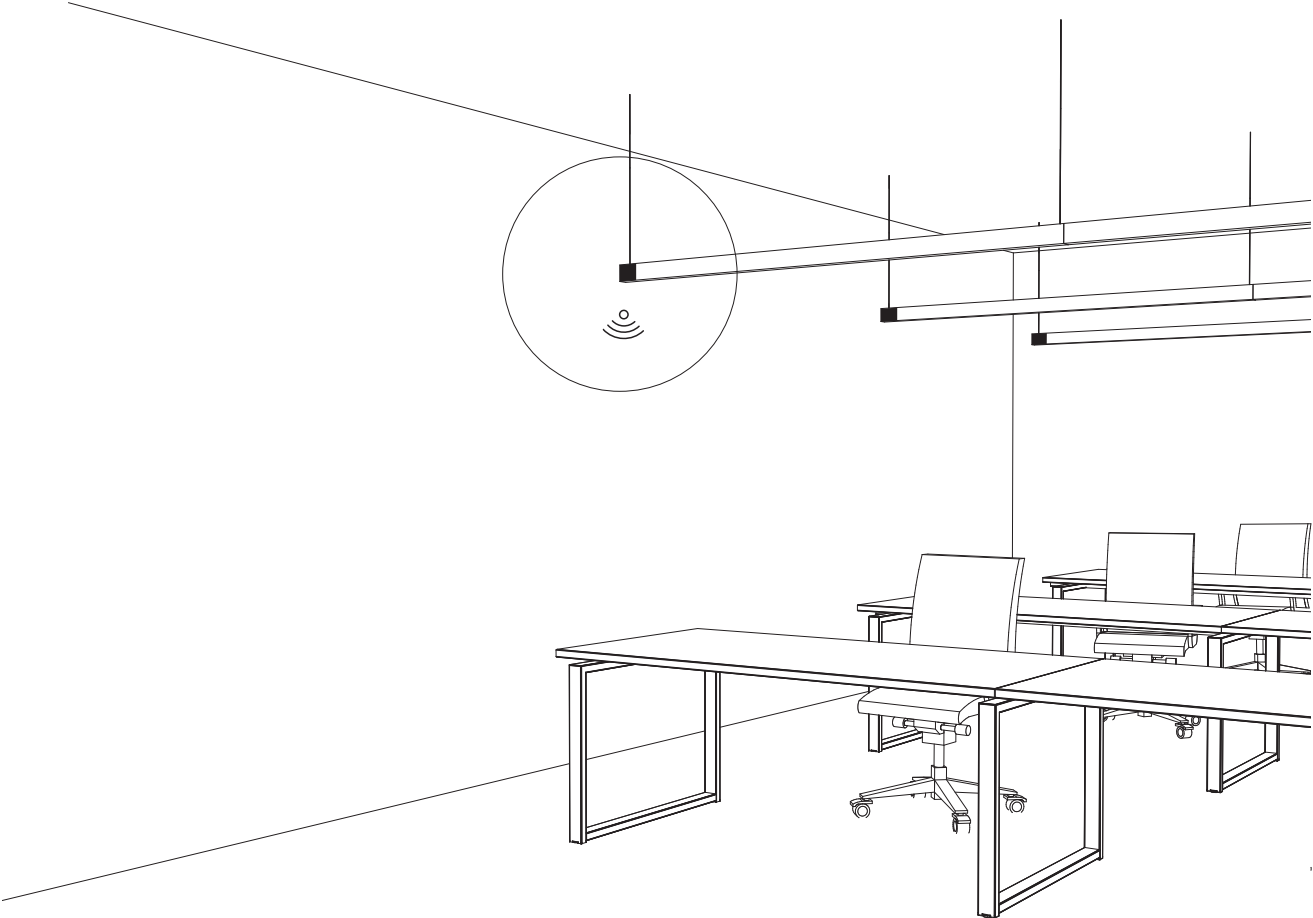

Traceline Recessed

EN With its super narrow width of 20 mm, Traceline Recessed integrates perfectly into any kind of architecture and space. Invisible yet powerful, with an outstanding lumen output up to 90 lm/W. It is available also in the Deep Recessed version: the recessed LED makes the light even more discreet and offers an excellent visual comfort.

IT Con la sua dimensione estremamente ridotta di soli 20 mm, il nuovo Traceline Recessed si integra perfettamente in qualsiasi tipo di architettura e spazio. Invisibile ma potente, con un eccezionale lumen output fino a 90 lm/W. È disponibile anche nella versione Deep Recessed: il LED arretrato rende la luce ancora più discreta e offre un eccellente comfort visivo.

24

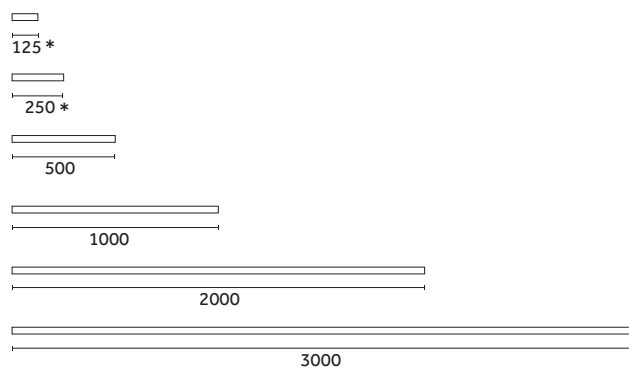

*Dark Performance and Recessed only

Optical solutions:



Control systems
p.22



Finishes
p.27



Traceline Track
48V p.44



Shapes
p.36

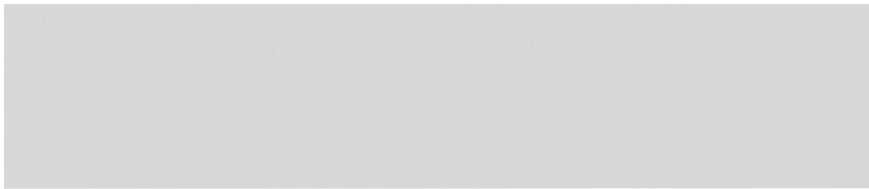

Traceline Recessed - Trimless

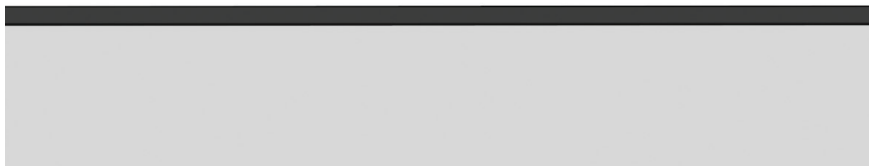
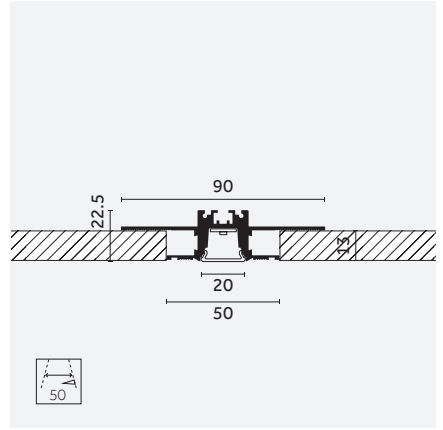

Traceline Recessed - Trim

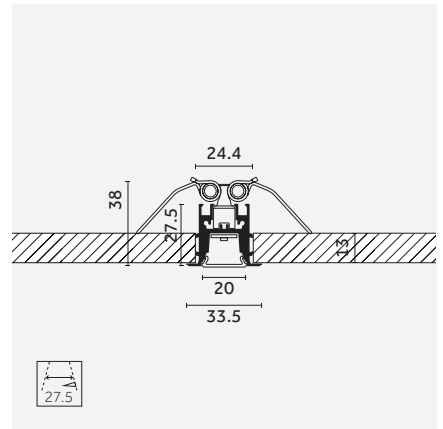

Traceline Deep Recessed - Trimless

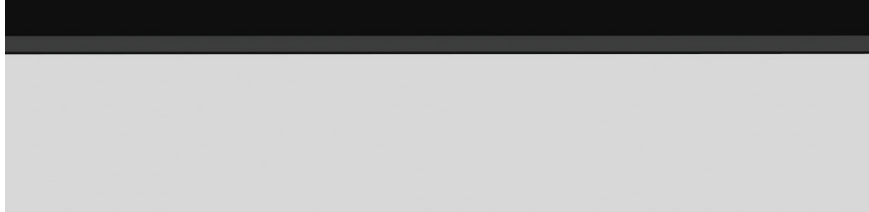
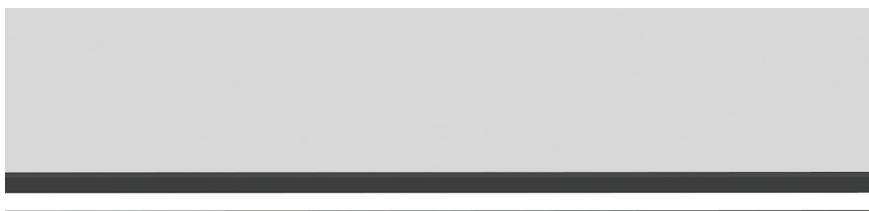
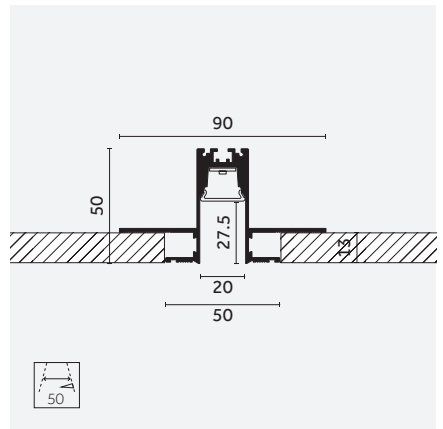

Traceline Deep Recessed - Trim

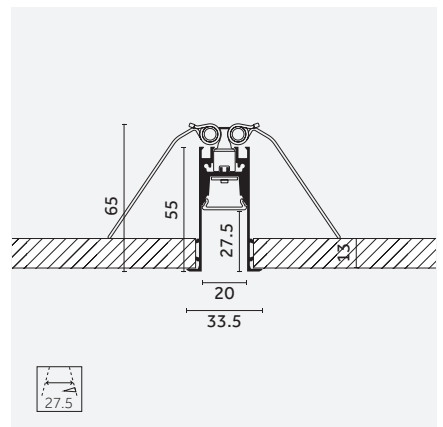

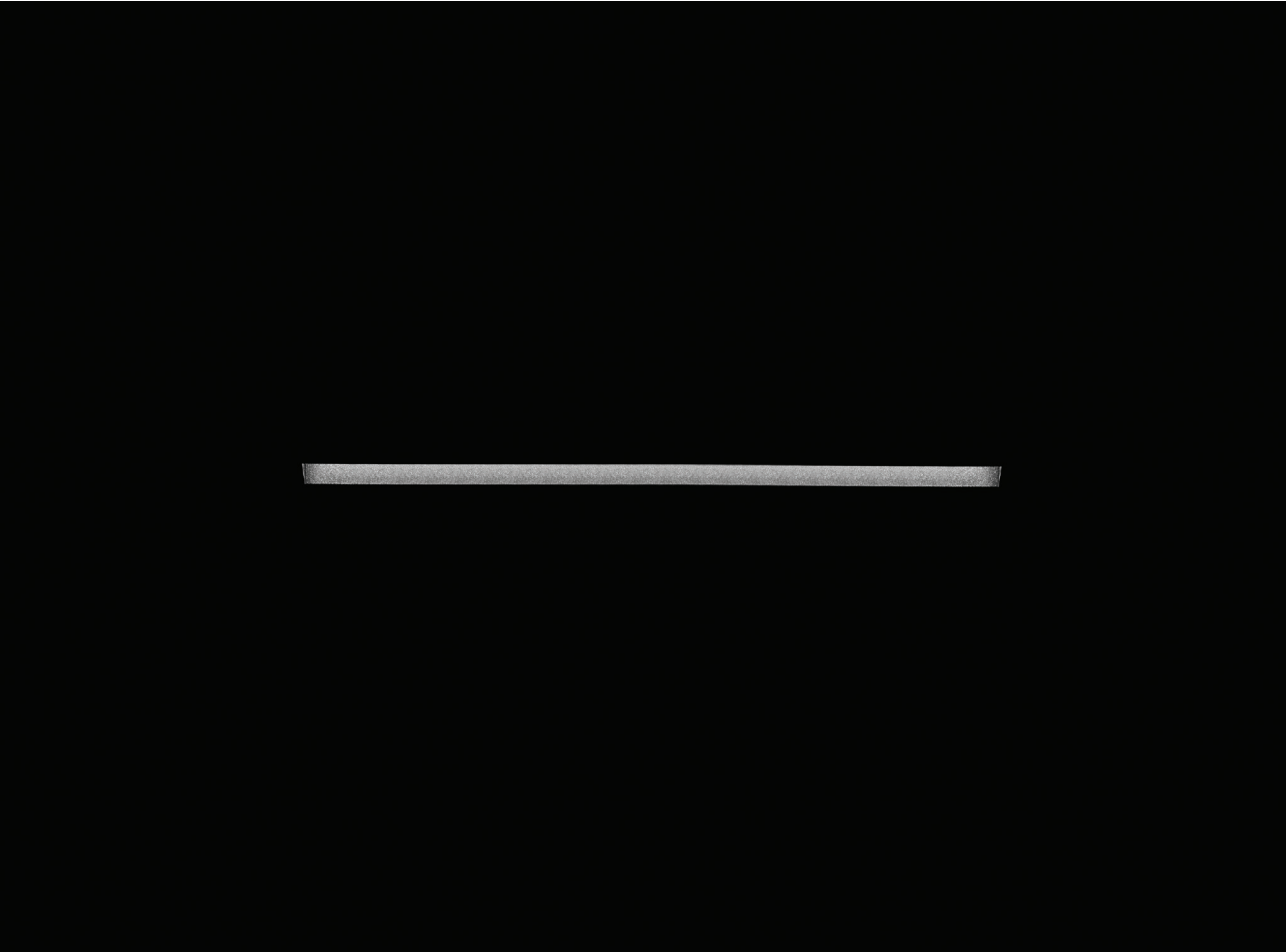

26

EN Traceline Deep Recessed - 500mm
IT Traceline Deep Recessed - 500mm

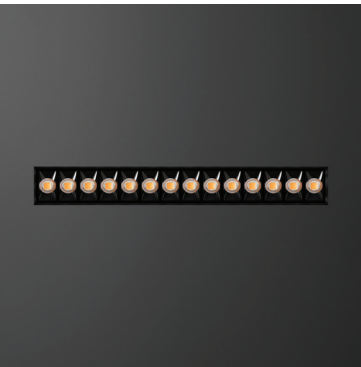

EN Traceline Recessed - Dark Performance diffuser
IT Traceline Recessed - Diffusore Dark Performance

Traceline Deep Recessed finishes:



EN **C0** Royal matt white
IT **C0** Bianco opaco royal



EN **12** Embossed matt white
IT **12** Bianco opaco goffrato

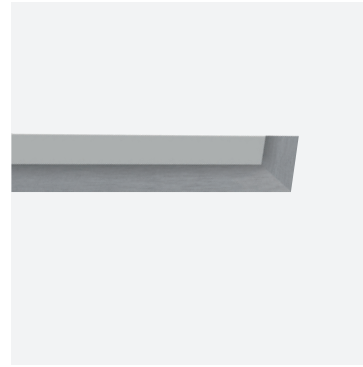

EN **M0** Brushed aluminium
IT **M0** Alluminio spazzolato



EN **B0** Royal Matt Black
IT **B0** Nero opaco royal



EN **31** Embossed matt black
IT **31** Nero opaco goffrato



EN **01** Chrome plated
IT **01** Cromo



EN **E0** Brushed gold
IT **E0** Oro spazzolato



EN **L0** Antiqued brushed bronze
IT **L0** Bronzo antico spazzolato

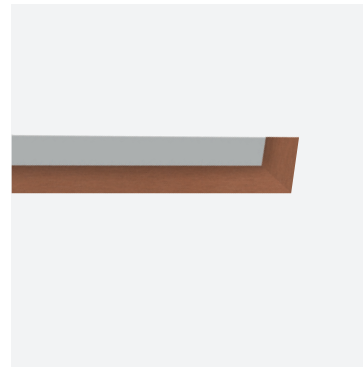

EN **N0** Brushed copper
IT **N0** Rame spazzolato

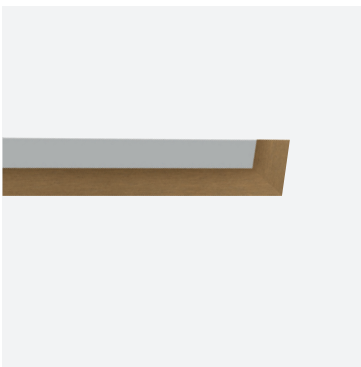

EN **D0** Brushed brass
IT **D0** Ottone spazzolato

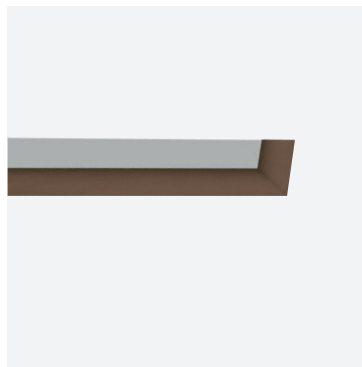

EN **T1** Anodized bronze
IT **T1** Bronzo anodizzato

Traceline

Surface/Pendant

EN Traceline Surface, particularly in the Continuous Line version, can become a distinctive graphic element, to be combined with architectural and design elements, or it can be integrated in coves and architectural details. Thanks to the integrated driver, it can even be installed when there is no false ceiling .

IT Traceline Surface, in particolare nella versione in linea continua, può diventare un elemento grafico distintivo, da combinare con elementi architettonici e di design, oppure può essere integrato in gole e dettagli architettonici. Grazie al driver integrato, può essere installato anche in assenza di controsoffitti.

28

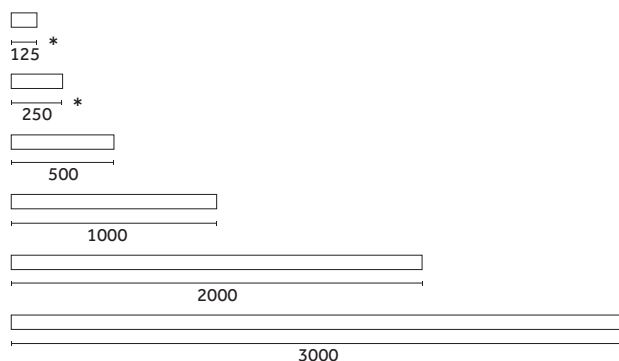
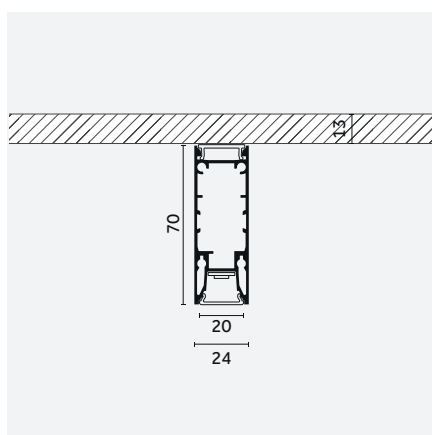

* Dark Performance only

Optical solutions:



Opal



Micro Prismatic



Dark Performance



Dark Grid



Dark Frosted



Control systems
p.22



Shapes
p.36



Traceline Track
48V p.44



Finishes
p.50

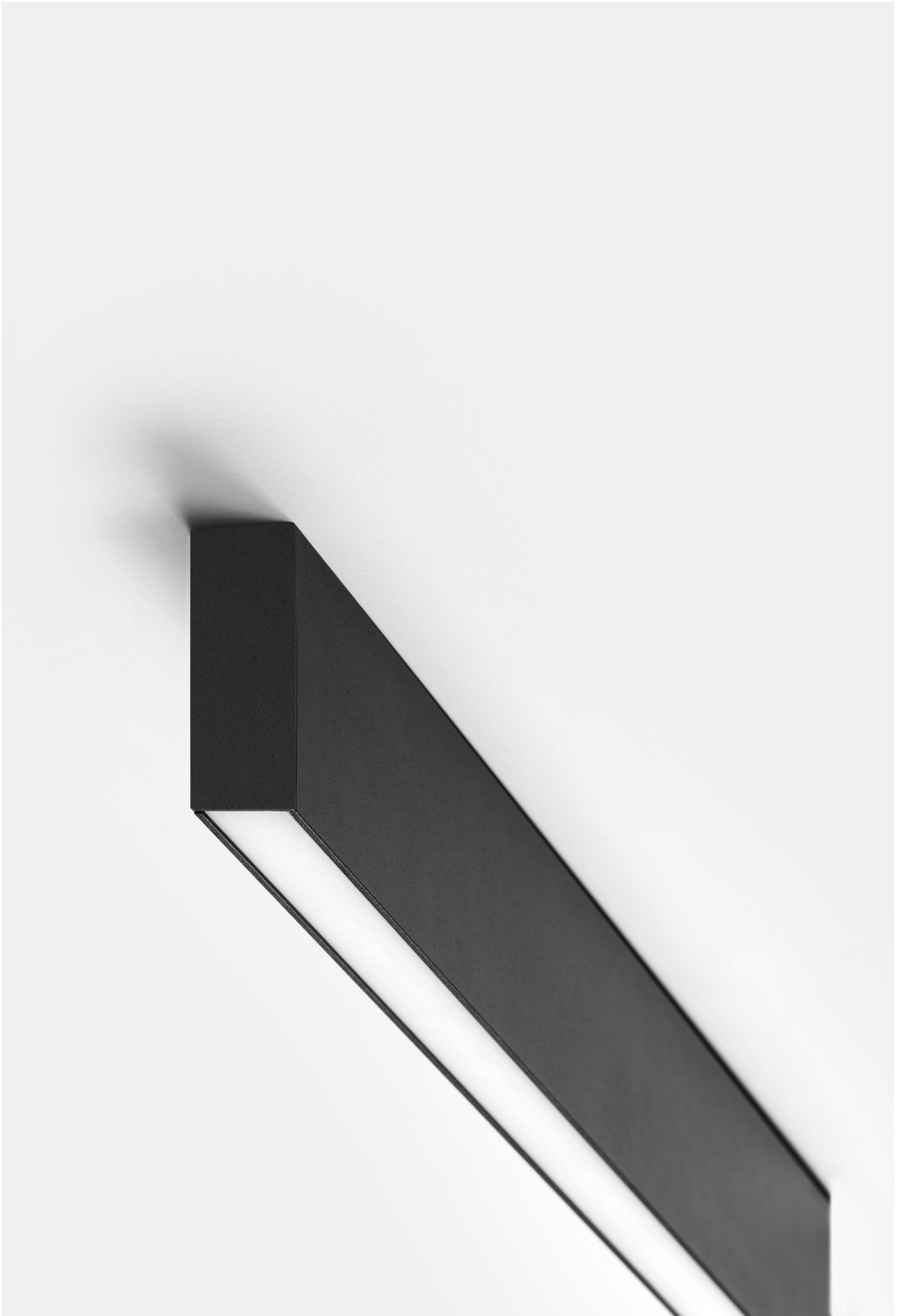

EN You can easily turn Traceline Surface into a pendant and wall luminaire using the bespoke accessories, both for single modules and for continuous line configuration.

IT È possibile trasformare facilmente Traceline Surface in un apparecchio a sospensione o a parete, utilizzando gli accessori personalizzati, sia per i moduli singoli che per la configurazione in linea continua.

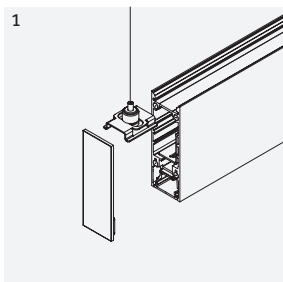

EN Pendant accessory
IT Accessorio per sospensione

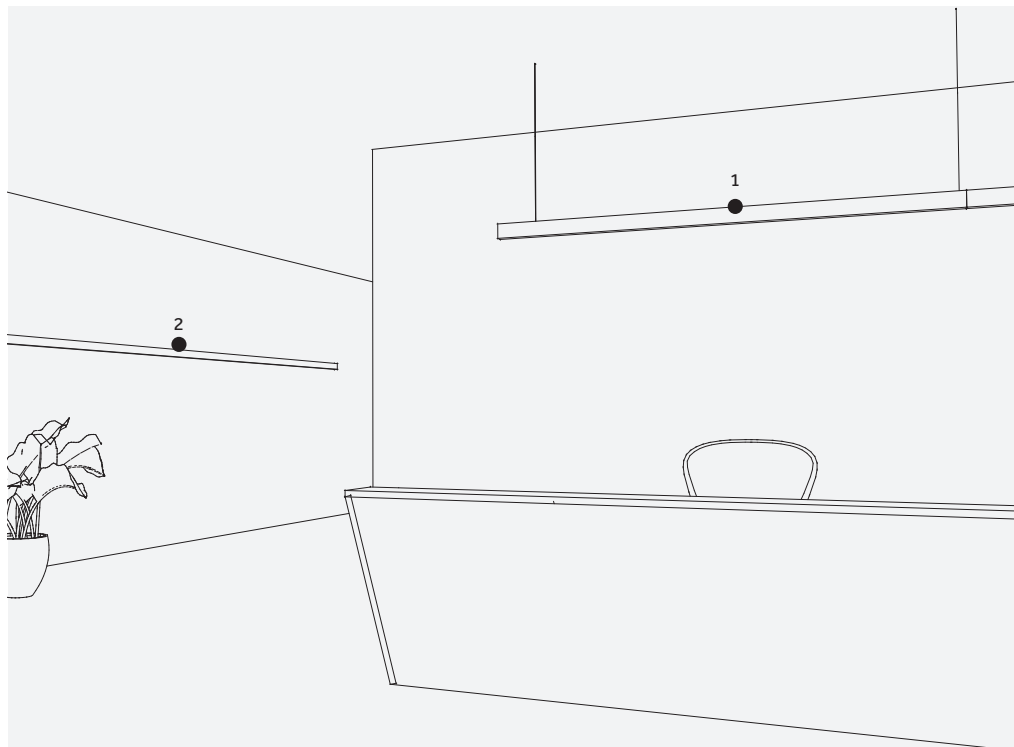

30

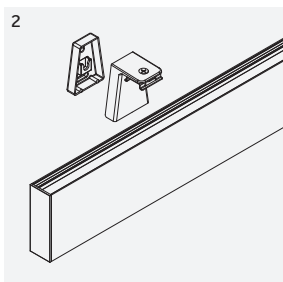

EN Traceline Surface (Wall)
IT Traceline Surface (Parete)

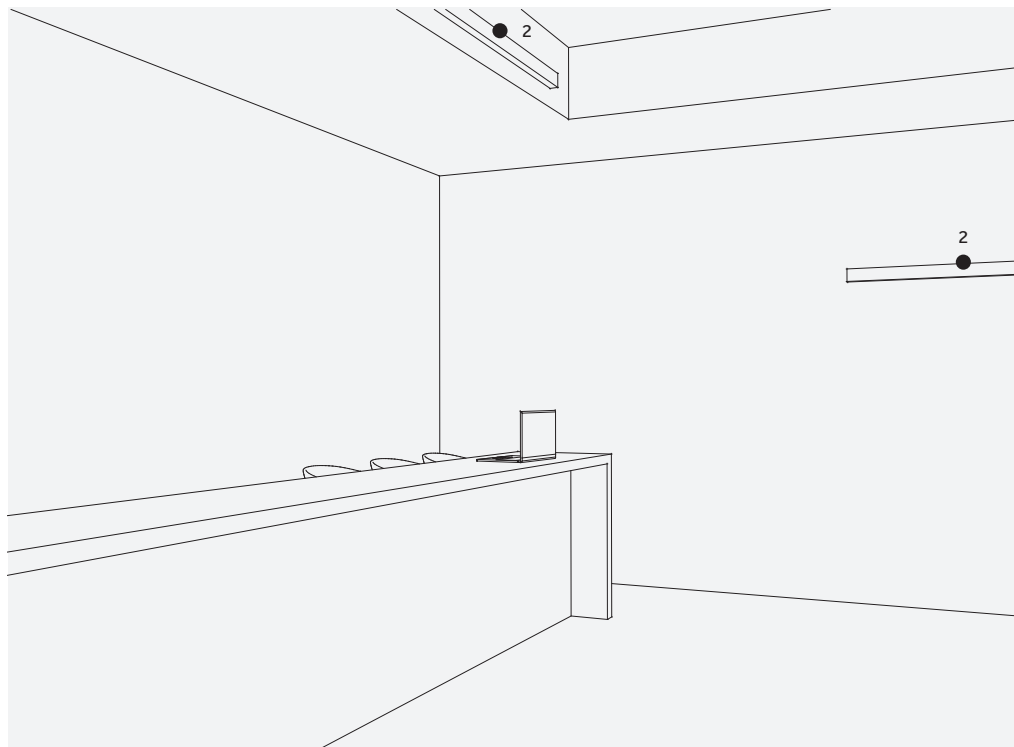



Traceline Pendant

Direct/Indirect

EN Minimalism and understatement encompassed in just 20 mm: Traceline Pendant offers a combination of direct light with visual-comforting indirect lighting to increase light levels and reduce contrasts. It can be installed single configuration and in continuous line, to realize uninterrupted lines of light.

IT Minimalismo e understatement racchiusi in soli 20 mm: Traceline Pendant offre una combinazione di luce diretta, diffusa e di illuminazione indiretta, per aumentare i livelli di illuminamento e ridurre i contrasti. Può essere installato in configurazione singola e in linea continua, per realizzare linee di luce ininterrotte.

32

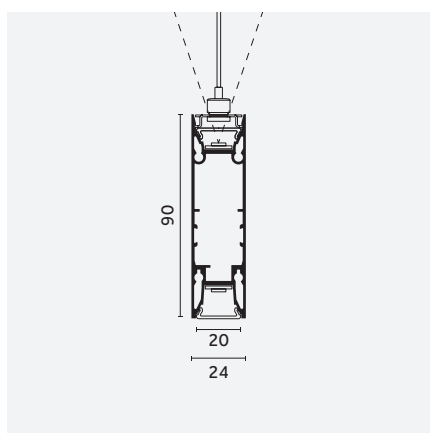

Traceline Pendant - Direct/Indirect

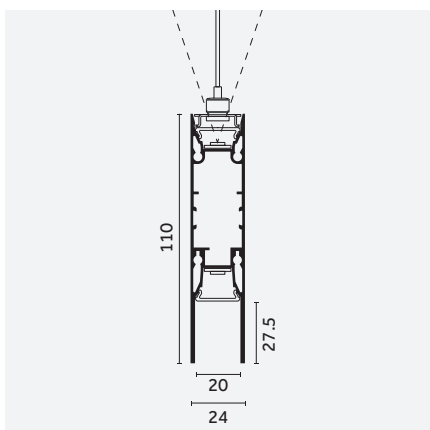
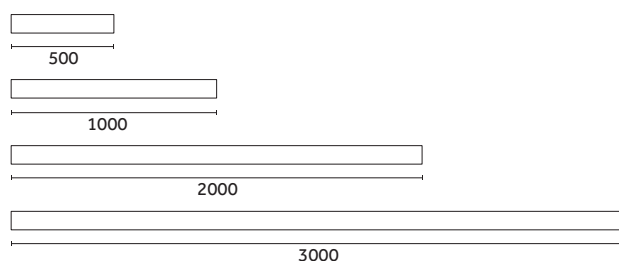

Traceline Deep Pendant - Direct/Indirect

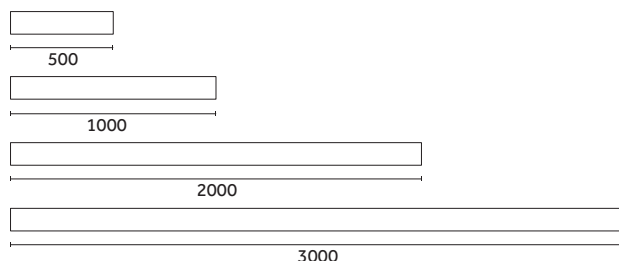



Optical solutions:



Opal



Micro Prismatic



Dark Performance



Dark Grid



Dark Frosted



Control systems
p.22



Shapes
p.36



Traceline Track
48V p.44



Finishes
p.50

^{EN} Power module with 3m cable included
^{IT} Power module con cavo da 3m incluso



EN Surface suspension set
IT Set sospensione a superficie

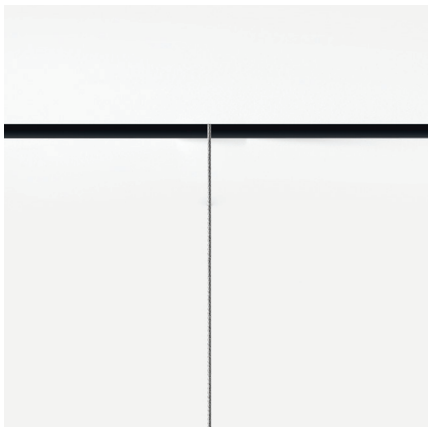

EN Ghostrack suspension set
IT Set sospensione Ghostrack



EN Tige
IT Tige

34

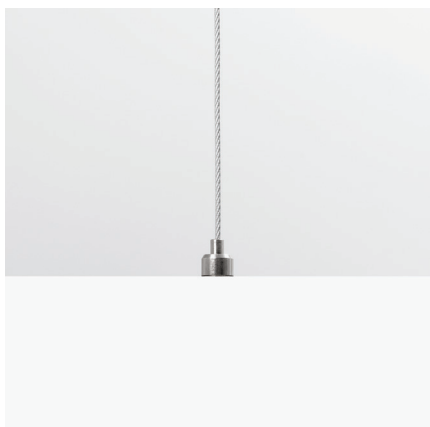

EN Clean and discreet, the joint can be moved at any time to adjust or change your configuration
IT La staffa "a pattino" minimal e discreta, può essere spostata in qualsiasi momento per regolare o modificare la tua configurazione.



Traceline

Angles and squares

^{EN} More than just linear lighting: Traceline offers you the freedom to play with squares and angles of different sizes. They can be Deep Recessed, Recessed, Surface, Pendant or Deep Pendant. Remoted driver for the Recessed versions and integrated controls for Surface and Pendant versions. Traceline Squares and angles are unique architectural and decorative solutions with performing optical options and outstanding colour finishes.

^{IT} Più che una semplice illuminazione lineare. Traceline ti offre la libertà di giocare con quadrati e forme di diverse dimensioni e applicazioni: Deep Recessed, Recessed, Surface, Deep Pendant e Pendant. Driver remoto per le versioni da incasso e controlli integrati per versioni Surface e Pendant. I quadrati e gli angoli sono soluzioni architettoniche e decorative uniche, con opzioni ottiche performanti e straordinarie finiture cromatiche.

36

Modules with light:

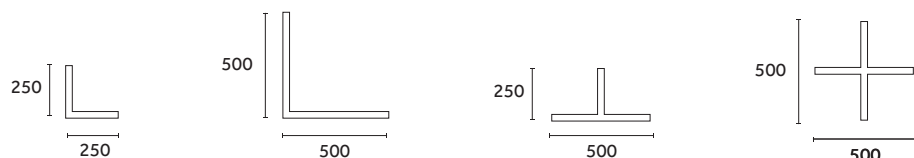

Mechanical joints:



Optical solutions:



Control systems
p.22



Finishes
p.50

^{EN} The modules with light can be used stand alone or with linears to complete your configuration

^{IT} Gli angoli possono essere utilizzati stand alone o con moduli lineari per completare la tua configurazione



Traceline Deep Recessed - "L"
(250x250)

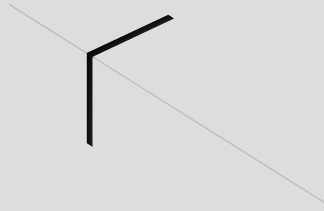

Traceline Deep Recessed - "L Wall"
(250x250)



Traceline Deep Recessed - "T"
(500x250)



Traceline Deep Recessed - "X"
(500x500)



Traceline Recessed - "L"
(250x250)



Traceline Recessed - "L Wall"
(250x250)



Traceline Recessed - "T"
(500x250)



Traceline Recessed - "X"
(500x500)



Traceline Surface - "L"
(500x500)

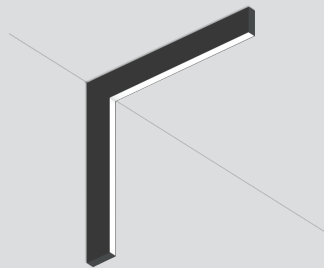

Traceline Surface - "L Wall"
(500x500)

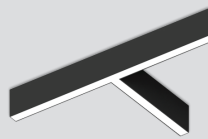

Traceline Surface - "T"
(500x250)

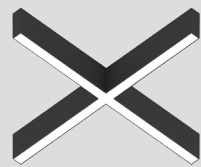

Traceline Surface - "X"
(500x500)

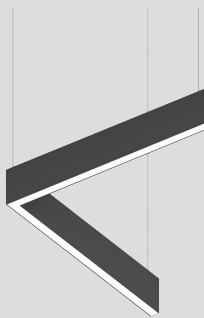

Traceline Pendant - "L"
(500x500)

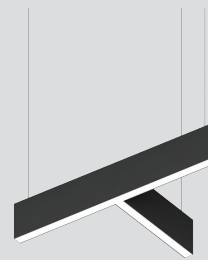

Traceline Pendant - "T"
(500x250)

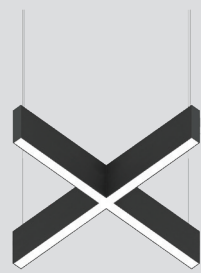

Traceline Pendant - "X"
(500x500)

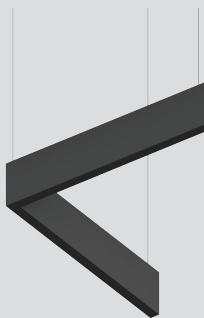

Traceline Deep Pendant - "L"
(500x500)

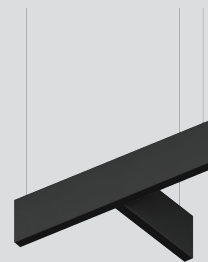

Traceline Deep Pendant - "T"
(500x250)

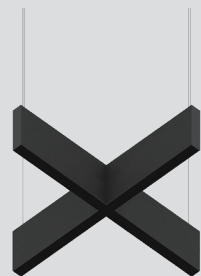

Traceline Deep Pendant - "X"
(500x500)

Squares applications:

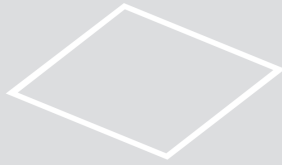
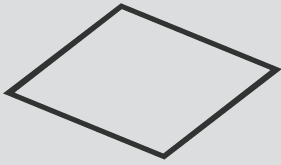

Traceline Deep Recessed Square

Traceline Recessed Square

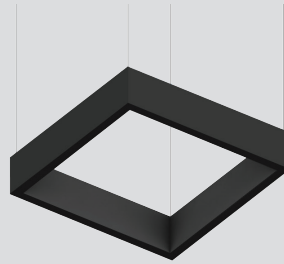
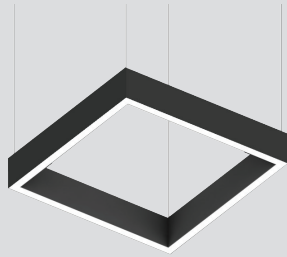
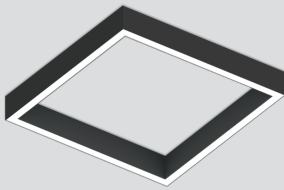

Traceline Surface Square

Traceline Pendant Direct/Indirect Square

Traceline Deep Pendant Direct/Indirect Square

38

Choose the size:



250x250



500x500



750x750

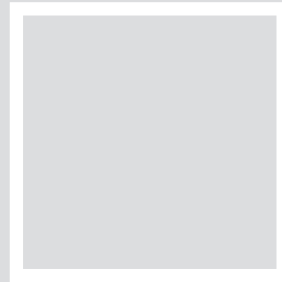

1000x1000

Optical solutions:



Opal



Micro Prismatic



Dark Performance



Dark Frosted



Control systems
p.22



Finishes
p.50







Continuous line

EN Traceline is available in single modules or in a continuous line configuration. The continuous option has been designed to offer the flexibility to create graphic light patterns and emphasize architectural lines. The continuous configuration can carry on adding other Power and Continuous modules without no limitations.

IT Traceline è disponibile in moduli singoli o nella configurazione in linea continua. La linea continua è stata progettata per offrire la flessibilità necessaria per creare pattern grafici luminosi e valorizzare linee e volumi architettonici. Nella configurazione in linea continua puoi aggiungere moduli Power e Continuous senza limitazioni.

42

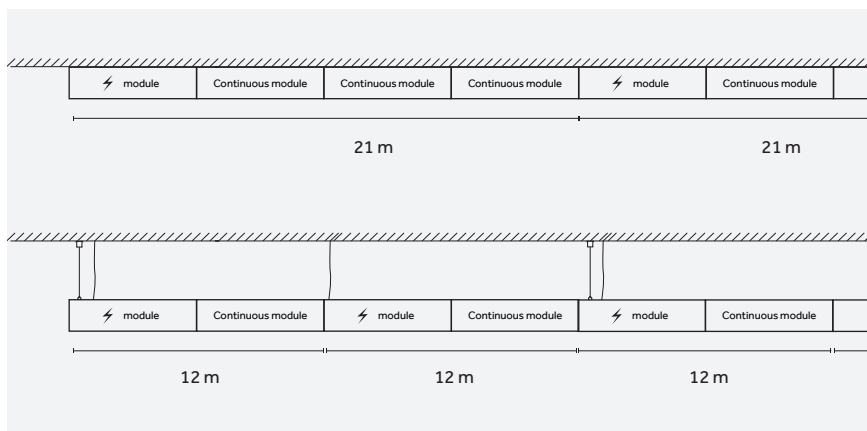

Traceline Surface (max 21m)
Traceline Pendant (max 12m)

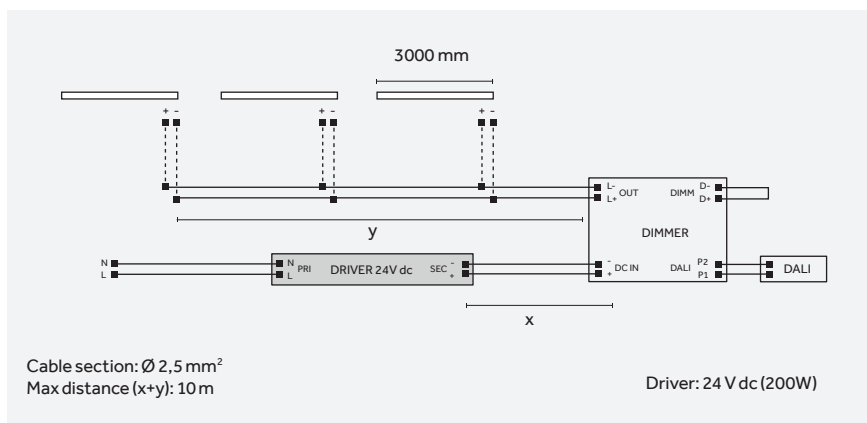

Configuration example: 3x Traceline Recessed - Dark Performance (3000 mm)



Traceline Track 48V

NEW

EN Traceline Track 48V is the latest addition to the Traceline family. We integrated a 48V track inside a Traceline module, to give you the possibility to add any Yori 48V spotlight, linear or suspension. You can easily combine Traceline Track 48V with the rest of the Traceline System to create endless lighting lines in a seamless manner: a new kind of flexibility.

IT Traceline Track 48V è l'ultima aggiunta alla famiglia Traceline. Abbiamo integrato un binario 48V all'interno di un modulo Traceline, per darti la possibilità di aggiungere proiettori, lineari o sospensioni 48V alla tua configurazione. Puoi combinare Traceline Track 48V con il resto del sistema Traceline per creare linee di illuminazione infinite senza soluzione di continuità: il massimo della flessibilità.

Applications:

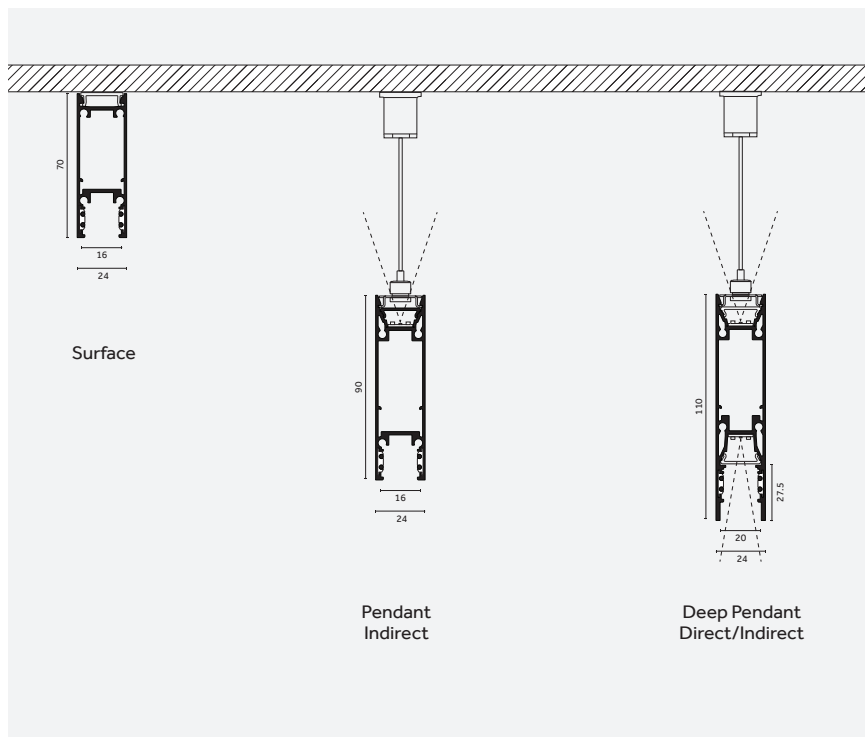

Modules:

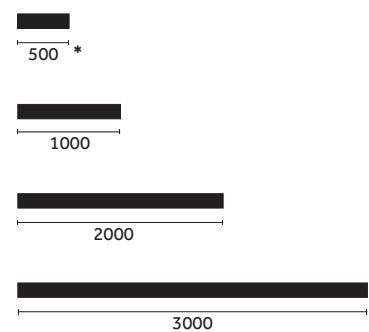

* Pendant and Deep Pendant versions available on request



What can you fit in?



^{EN} Completa la tua configurazione aggiungendo Yori Evo 48V system: spot, lineare o sospensione.

^{IT} Complete your lighting scheme adding Yori Evo 48V system: spotlight, linear or suspension.

Traceline

^{EN} Integrating accent lighting into your ambient lighting has never been easier. Traceline Track 48V, in the Deep Pendant version, has both direct and indirect lighting: you can freely add spotlights or suspensions any time, creating a unique combination of diffused and accent lighting.

^{IT} Integrare l'illuminazione d'accento in un progetto con luce d'ambiente non è mai stato così facile. Traceline Track 48V, nella versione Deep Pendant, presenta infatti luce sia diretta che indiretta: puoi aggiungere liberamente spot o sospensioni in qualsiasi momento, creando una combinazione unica di luce diffusa e d'accento.

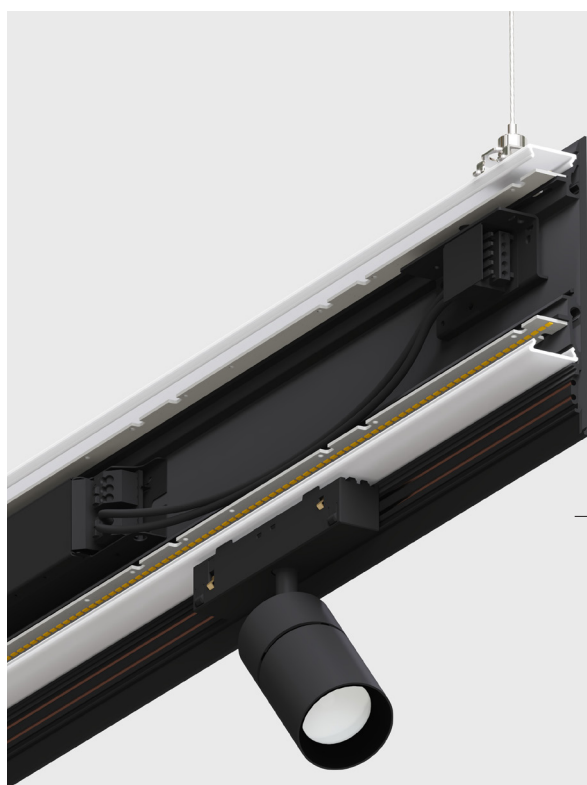

INDIRECT LIGHT

^{EN} Opal diffuser and LED source (Tunable White and Warm Dimming versions available) for indirect light
^{IT} Diffusore Opal e sorgente LED (opzioni Tunable White e Warm Dimming disponibili) per luce indiretta.

DIRECT LIGHT

^{EN} Opal, Microprismatic or Dark frosted diffuser and LED source (Tunable White and Warm Dimming versions available) for direct light
^{IT} Diffusore Opal, Microprismatico o Dark Frosted e sorgente LED (opzioni Tunable White e Warm Dimming disponibili) per luce diretta.

INTEGRATED 48V TRACK

^{EN} An integrated low voltage track to carry Yori 48V (Spot or pendant).
^{IT} Binario 48V integrato nel profilo per ospitare i prodotti Yori 48V (Spot e pendant).



Fade: complete your lighting scheme

EN Minimalism and understatement encompassed in just 22,5 mm and 12 mm height: Fade offers the flexibility of a unique small profile with different combinations of LED Tapes and three different diffusers. A series of mounting accessories allows the integration in any architecture, display or furnishing detail.

IT Minimalismo e understatement racchiusi in soli 22,5 mm di larghezza e 12 mm di altezza: Fade offre la flessibilità di un profilo dalle dimensioni estremamente ridotte con diverse combinazioni di tape LED e tre diversi diffusori. Una serie di accessori di montaggio consente l'integrazione in qualsiasi architettura, vetrina o dettaglio d'arredo.

Create your Fade:

48

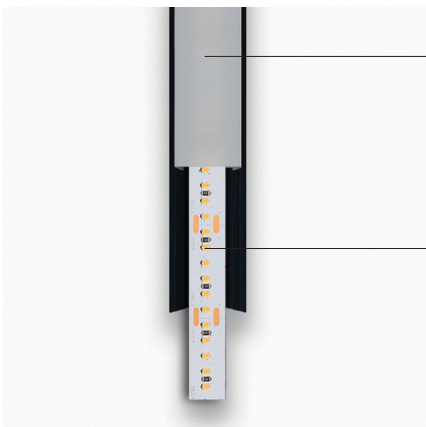

Length: up to 3000 mm

Choose the diffuser:

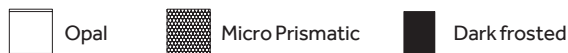

Choose the light temperature:

LED	Warm Dimming (1800-2700 K)	CRI > 90	IP 20
	Tunable White (2200-6500 K)	CRI > 90	IP 20
	Standard (2200, 2700, 3000, 3500, 4000 K)	CRI > 95	IP 20
	IP65 (2200, 2700, 3000, 3500, 4000 K)	CRI > 90	IP 65

For product codes visit: reggiani.net

Fixing system:

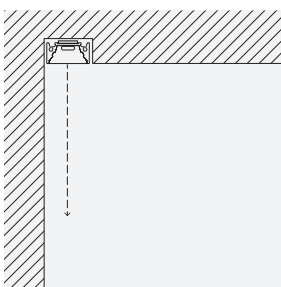

EN Double sided tape
IT Tape biadesivo

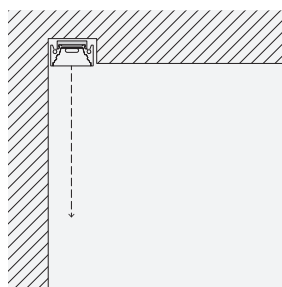

EN Surface bracket
IT Staffa a superficie

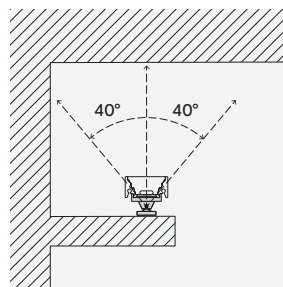

EN Adjustable bracket
IT Staffa orientabile

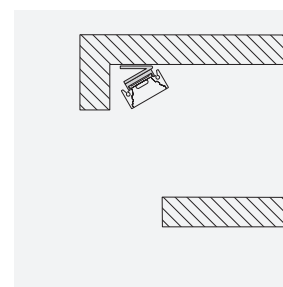

EN Tilted fixed Bracket (15°/30°/45°/60°)
IT Staffa fissa orientata (15°/30°/45°/60°)



Finishes

50

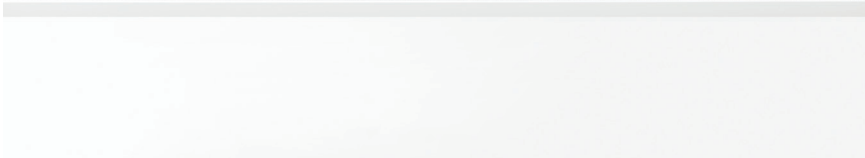

^{EN} 12 Embossed matt white
^{IT} 12 Bianco opaco goffrato

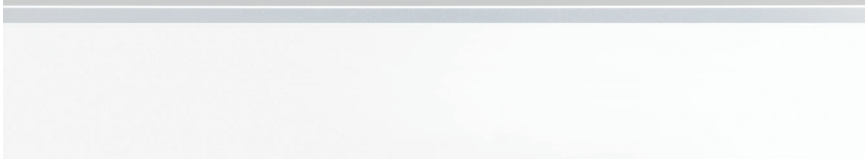

^{EN} C0 Royal matt white
^{IT} C0 Bianco opaco royal



EN **01** Chrome plated
IT **01** Cromo



EN **31** Embossed matt black
IT **31** Nero opaco goffrato



EN **B0** Royal Matt Black
IT **B0** Nero opaco royal



^{EN} **M0** Brushed aluminium
^{IT} **M0** Alluminio spazzolato



^{EN} **E0** Brushed gold
^{IT} **E0** Oro spazzolato



^{EN} **D0** Brushed brass
^{IT} **D0** Ottone spazzolato



EN **T1** Anodized bronze
IT **T1** Bronzo anodizzato



EN **L0** Antiqued brushed bronze
IT **L0** Bronzo antico spazzolato



EN **N0** Brushed copper
IT **N0** Rame spazzolato



EN "Natural collection" on request
IT "Natural collection" su richiesta

Codes

^{EN} Scan the QR code to discover the "Traceline System" webpage on reggiani.net with codes, technical drawings and insights.

^{IT} Inquadra il QR code per scoprire la pagina "Traceline System" su reggiani.net con codici, disegni tecnici e approfondimenti.



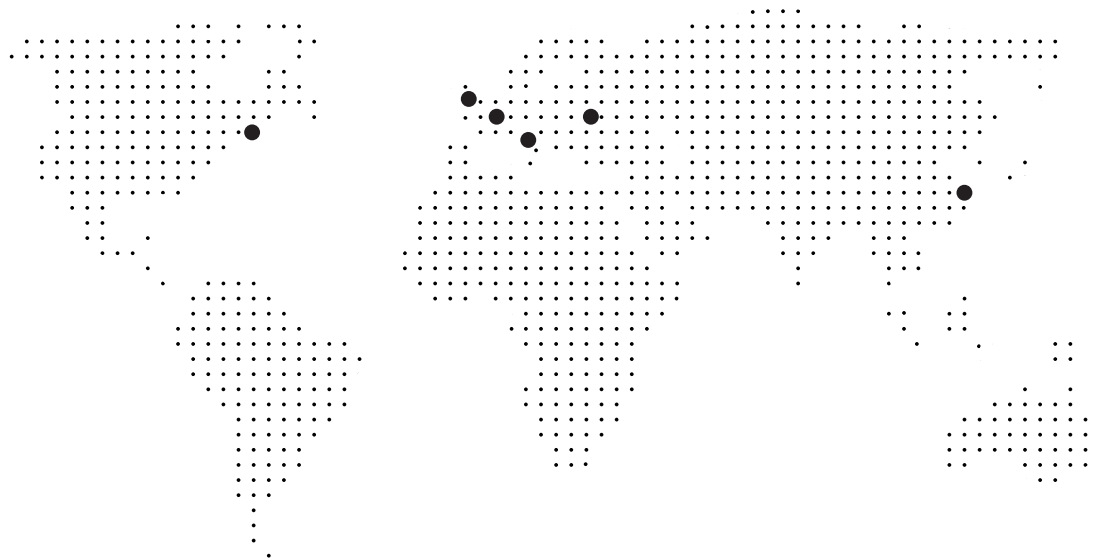

ITALY
Reggiani S.p.A. Illuminazione
Headquarters

Viale Monza 16 P.O. Box 99
20845 Sovico (MB), Italy
T. (+39) 039 20711
contact@reggiani.net

USA
Reggiani Lighting USA, inc.

372 Starke Road
Carlstadt NJ 07072, USA
T. (+1) 201 372 1717
info@reggianiusa.com
www.reggianiusa.com

FRANCE
Sales office

39 Bd. Richard Lenoir, Bastille
75011 Paris, France
T. (+33) 01 43382704
france@reggiani.net

UNITED KINGDOM
Reggiani Ltd

28 Cowper Street
London, EC2A 4AS
T. (+44) 02082363000
reggiani@reggiani.co.uk

CHINA
Reggiani Ningbo ITG Lighting co. Ltd

Shenjia Village - Qiuai Town - Yinzhou
315010 Ningbo, China
T. (+86) 574 88418655 - 88412627
info@itglight.com

RUSSIA
Sales office

Kalanchevskaya Street, 16,
Building 1, Room 4A, 129090 Moscow
T. (+7) 495 2690113 - 846 3320266
russia@reggiani.net

©
2021
Reggiani S.p.A. Illuminazione
All rights reserved

Art direction
Reggiani Creative Team

Graphic design
Reggiani Creative Team

Print
Cattaneo Grafiche

Worldwide distributors

For the worldwide distributors list visit
www.reggiani.net



Reggiani

[#theilluminationcollective](https://www.theilluminationcollective.com)

www.reggiani.net

Reggiani